

StickyMat System

Quick and easy installation

Strong fibreglass mesh with pressure sensitive adhesive, for the fastest and most secure installation of electric underfloor heating.

No increase in floor levels

With an ultra-thin, dual fluoropolymer coated heating wire.

Suitable for all builds

StickyMat underfloor heating system is suitable for all building projects; retrofits, new builds and refurbishments.

For regular shaped rooms

Ideal for installations within regularly shaped areas - quickly rolling out the 0.5m wide mats in parallel runs.



Overview

The Warmup StickyMat System is designed for use within the adhesive layer under tiles or within a levelling compound under other floor finishes. The fixed spacing and self-adhesive mat makes installation of regularly shaped rooms quick and easy whilst ensuring precision is maintained.

The pressure sensitive adhesive securely binds the mats to the floor, keeping them flat and ensuring the application of tile adhesive is snag free whilst allowing the mats to be easily repositioned as needed.

The ultra-thin, multi-strand, dual core heating cable, is double insulated with an advanced fluoropolymer making it exceptionally tough and easy to tile over.

For floors using a vinyl, carpet, timber or other underfloor heating compatible floor finishes including tiles, the system can be covered with a levelling compound to provide a flat and level floor surface. StickyMats are available in both 150 W/m² and 200 W/m² variants making them ideal for use as the primary heat source within modern homes and most older properties.

Warmup

Typical floor build-up

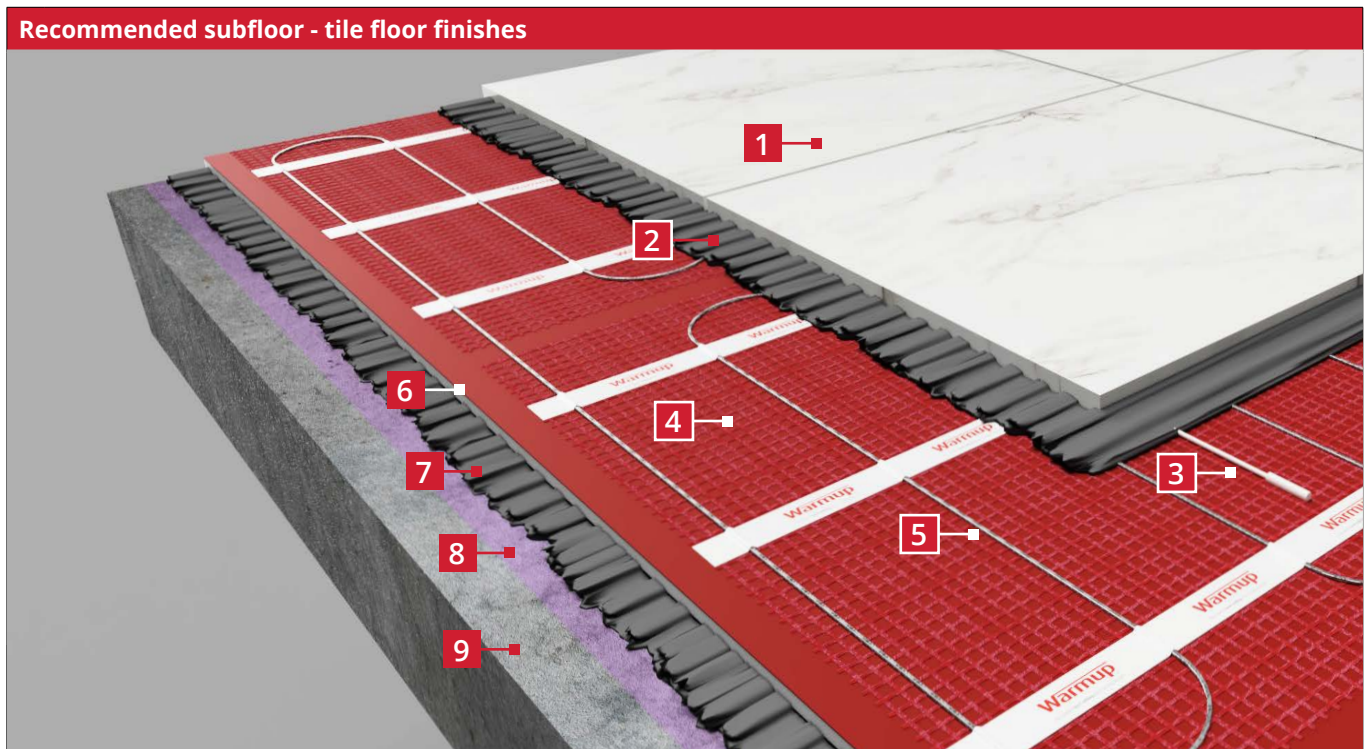

- 1 **Tile floor finish**
- 2 **Flexible tile adhesive**
- 3 **Floor sensor**
Tab tape the sensor to the subfloor. Do not tape over the sensor tip!
- 4 **Fibreglass mesh with pressure sensitive adhesive**
Apply pressure to the mesh to ensure a secure bond to the subfloor
- 5 **Heating cable**
DO NOT cut at any stage!
- 6 **Warmup Ultralight (optional)**
Adding Warmup Ultralight below StickyMat can help improve the response time of the system, particularly when installing over screed or concrete
- 7 **Flexible tile adhesive (optional)**
Required if installing Warmup Ultralight
- 8 **Warmup primer**
Refer to tile adhesive manufacturers instructions for priming requirements
- 9 **Pre-insulated subfloor with a surface regularity of SR1***

*If installing the optional Warmup Ultralight, refer to its installation manual for its subfloor requirements.

Cable section

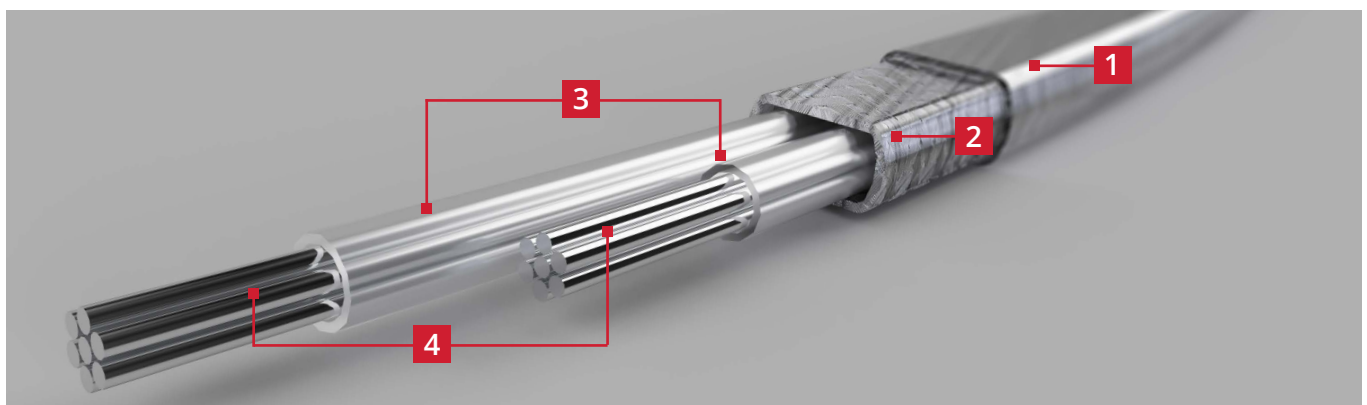

- 1 ETFE outer insulation
- 2 Earth braiding surrounding heating cores
- 3 ETFE inner insulation
- 4 Dual core, multi-strand heating element

Technical specifications

Product code	SPM* / 2SPM* PFM* / 2PFM*	Inner / outer insulation	ETFE
Connection	3.0 m long coldtail Flat 2 core cable with earth braid	Cable covering	Translucent
		Cable spacing	80 mm (+/-3 mm)
Operating voltage	230 V AC: 50 Hz	Mesh	Sticky pressure sensitive fibreglass mesh
IP rating	X7	Mesh colour	Red (150 W/m ²) / Blue (200 W/m ²)
Output rating	150 W/m ² (SPM, PFM) / 200 W/m ² (2SPM, 2PFM)	Earth protection	Metal braiding surrounding heating cores
Heating cores	Dual core, multi-strand heating element	Minimum installation temperature	-10 °C

StickyMat 150 W/m² system

Product code	Mat size (m)	Power (W)	Current (A)	Resistance (Ω)	Resistance band (Ω)		
SPM/PFM 1 m ²	0.5 x 2	150	0.65	352.7	335.0	-	370.3
SPM/PFM 1.5 m ²	0.5 x 3	225	0.98	235.1	223.4	-	246.9
SPM/PFM 2 m ²	0.5 x 4	300	1.30	176.3	167.5	-	185.2
SPM/PFM 2.5 m ²	0.5 x 5	375	1.63	141.1	134.0	-	148.1
SPM/PFM 3 m ²	0.5 x 6	450	1.96	117.6	111.7	-	123.4
SPM/PFM 3.5 m ²	0.5 x 7	525	2.28	100.8	95.7	-	105.8
SPM/PFM 4 m ²	0.5 x 8	600	2.61	88.2	83.8	-	92.6
SPM/PFM 4.5 m ²	0.5 x 9	675	2.93	78.4	74.5	-	82.3
SPM/PFM 5 m ²	0.5 x 10	750	3.26	70.5	67.0	-	74.1
SPM/PFM 6 m ²	0.5 x 12	900	3.91	58.8	55.8	-	61.7
SPM/PFM 7 m ²	0.5 x 14	1050	4.57	50.4	47.9	-	52.9
SPM/PFM 8 m ²	0.5 x 16	1200	5.22	44.1	41.9	-	46.3
SPM/PFM 9 m ²	0.5 x 18	1350	5.87	39.2	37.2	-	41.1
SPM/PFM 10 m ²	0.5 x 20	1500	6.52	35.3	33.5	-	37.0
SPM/PFM 11 m ²	0.5 x 22	1650	7.17	32.1	30.5	-	33.7
SPM/PFM 12 m ²	0.5 x 24	1800	7.83	29.4	27.9	-	30.9
SPM/PFM 15 m ²	0.5 x 30	2250	9.78	23.5	22.3	-	24.7

StickyMat 200 W/m² system

Product code	Mat size (m)	Power (W)	Current (A)	Resistance (Ω)	Resistance band (Ω)		
2SPM/2PFM 0.5m ²	0.5 x 1	100	0.43	529.0	502.6	-	555.5
2SPM/2PFM 1m ²	0.5 x 2	200	0.87	264.5	251.3	-	277.7
2SPM/2PFM 1.5m ²	0.5 x 3	300	1.30	176.3	167.5	-	185.2
2SPM/2PFM 2 m ²	0.5 x 4	400	1.74	132.3	125.6	-	138.9
2SPM/2PFM 2.5m ²	0.5 x 5	500	2.17	105.8	100.5	-	111.1
2SPM/2PFM 3m ²	0.5 x 6	600	2.61	88.2	83.8	-	92.6
2SPM/2PFM 3.5m ²	0.5 x 7	700	3.04	75.6	71.8	-	79.4
2SPM/2PFM 4m ²	0.5 x 8	800	3.48	66.1	62.8	-	69.4
2SPM/2PFM 4.5m ²	0.5 x 9	900	3.91	58.8	55.8	-	61.7
2SPM/2PFM 5m ²	0.5 x 10	1000	4.35	52.9	50.3	-	55.5
2SPM/2PFM 6m ²	0.5 x 12	1200	5.22	44.1	41.9	-	46.3
2SPM/2PFM 7m ²	0.5 x 14	1400	6.09	37.8	35.9	-	39.7
2SPM/2PFM 8m ²	0.5 x 16	1600	6.96	33.1	31.4	-	34.7
2SPM/2PFM 9m ²	0.5 x 18	1800	7.83	29.4	27.9	-	30.9
2SPM/2PFM 10m ²	0.5 x 20	2000	8.70	26.5	25.1	-	27.8
2SPM/2PFM 15m ²	0.5 x 30	3000	13.04	17.6	16.8	-	18.5

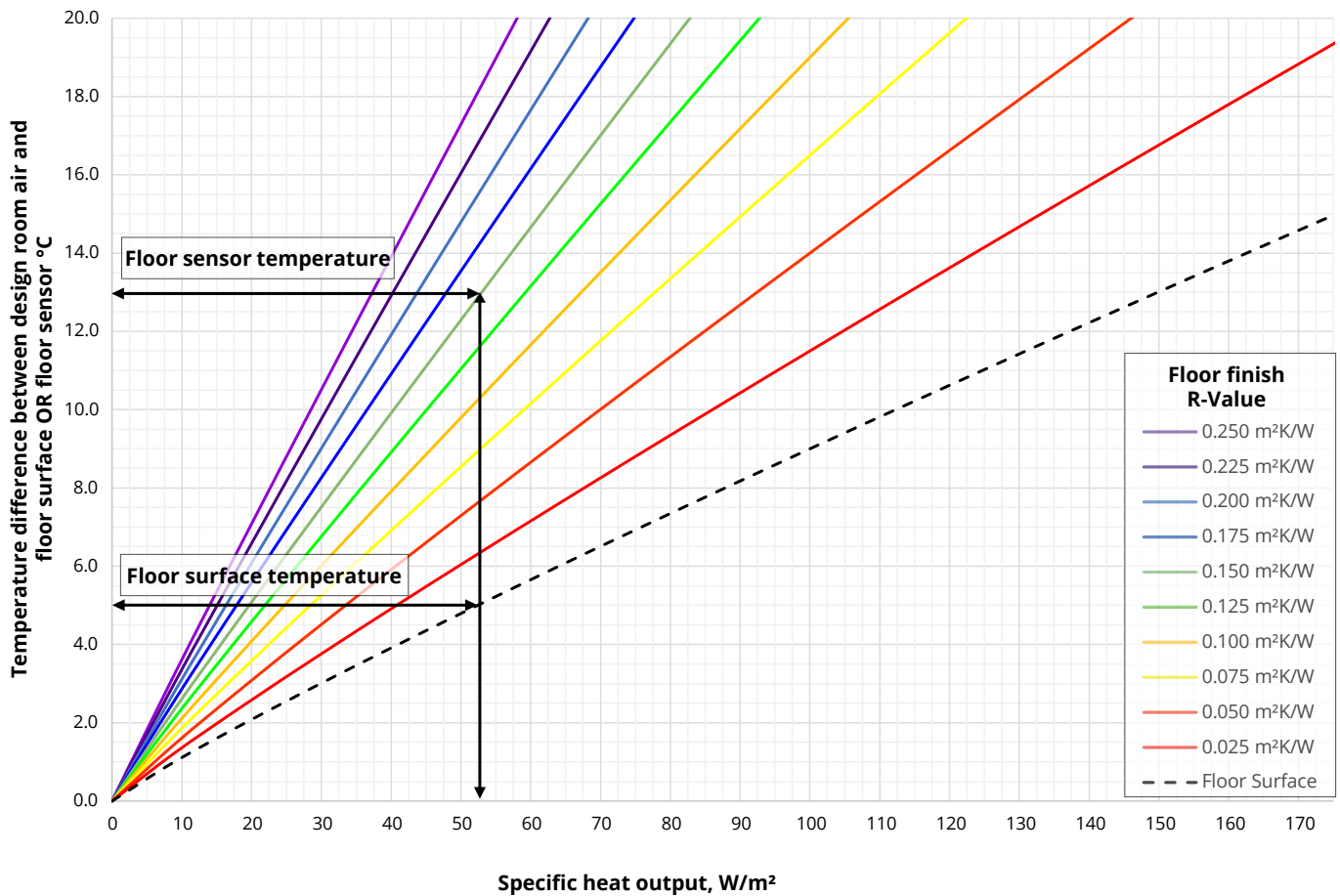

System performance

Floor sensor setting for target heat output



Using the graph above it is possible to get the specific heat output of an eUFH system based on the temperature difference between the design room air temperature and the floor surface or floor sensor temperature by floor finish.

The example above shows that for a design room air temperature of 20°C and floor surface temperature of 25°C. Based on the temperature difference of 5°C the resulting heat output would be 52.5 W/m². Based on a 0.150 m²K/W (1.5 Tog) floor finish the floor sensor would have to be set to 33°C to achieve this heat output.

-  The design floor surface temperature difference should not be more than 9 °C in occupied areas, 15 °C in unoccupied areas.
-  Heat output is limited by the floor finish resistance combined with the maximum probe setting of 40 °C.
-  Temperature limits of the floor finish or its adhesive may adversely limit the design heat output.

Components

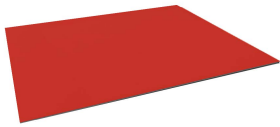

Warmup Ultralight (optional) - WCI-6 / WCI-16

Adding Warmup Ultralight below the membrane will improve the response time of the system, particularly when installing over screed or concrete. In addition it will provide better heat spread and decoupling.



Warmup 6iE - 6iE-01-OB-DC / 6iE-01-BP-LC

The world's first underfloor heating thermostat with a smartphone touchscreen providing effortless control at your fingertips. Connected to the internet by WiFi, it can be controlled from a smart phone, tablet or computer as well as its own touchscreen interface. Working automatically; it learns your routines and location through background communication with your smartphone. Using this knowledge it suggests ways to save energy.



Warmup Element - RSW-01-WH-RG (ELM-01-WH-RG) / RSW-01-OB-DC (ELM-01-OB-DC)

Warmup's Element WiFi Thermostat has been designed with simplicity and stylish functionality in mind. It brings energy-efficient heating control to all Warmup floor heating. Combining smart technology with simple, contemporary design, the Element WiFi Thermostat is the perfect all-rounder to control Warmup heating systems.



Warmup Primer - ACC-PRIMER

A ready to use, bond enhancing and solvent-free single component primer for the preparation of absorbent and non-absorbent floors and walls with or without surface heating.



Warmup perimeter strip - DCM-E-25

High quality foam perimeter strip, to allow for differential movement between finished floor level and walls when self-levelling over the StickyMat system

Mapei Ultraplan Renovation Screed 3240 - ACC-SELFLEVEL

Fibre reinforced levelling compound designed for use in the refurbishment of existing floors in both commercial and domestic applications. Used for interior levelling, smoothing and infilling differences in thickness from 3 to 40 mm on new or existing concrete, screeds, stone, terrazzo and ceramic tiles, old and new timber floors, floor boards, chipboard panels, plywood, parquet for use in dry locations as an underlayment for floor finishes such as tile, stone, vinyl, carpet and wood flooring.

Contact

Warmup xxx

www.warmup.xxx

xx@warmup.com

T: xxxx xxx xxxx

Warmup plc ■ 704 Tudor Estate ■ Abbey Road ■ London ■ NW10 7UW ■ UK

Warmup GmbH ■ Ottostraße 3 ■ 27793 Wildeshausen ■ DE