



## DECLARATION OF PERFORMANCE



**DoP: 0127**

for fischer High-Performance Anchor FH II, FH II-I (Metal anchors for use in concrete (heavy-duty type)) – EN

1. Unique identification code of the product-type: **DoP: 0127**
2. Intended use/es: **Post-installed fastening in cracked or uncracked concrete, see appendix, especially Annexes B 1 to B 6**
3. Manufacturer: **fischerwerke GmbH & Co. KG, Klaus-Fischer-Straße 1, 72178 Waldachtal, Germany**
4. Authorised representative: --
5. System/s of AVCP: **1**
6. European Assessment Document: **EAD 330232-00-0601**  
European Technical Assessment: **ETA-07/0025; 2018-08-28**  
Technical Assessment Body: **DIBt**  
Notified body/ies: **1343 – MPA Darmstadt**

7. Declared performance/s:

**Mechanical resistance and stability (BWR 1),**

- **Characteristic resistance to tension load (static and quasi-static loading): See appendix, especially Annexes C 1 and C 2**
- **Characteristic resistance to shear load (static and quasi-static loading): See appendix, especially Annexes C 3 and C 4**
- **Displacements (static and quasi-static loading): See appendix, especially Annexes C 9 and C 10**
- **Characteristic resistance and displacements for seismic performance categories C 1 and C 2: See appendix, especially Annexes C 7, C 8 and C 10**

**Safety in case of fire (BWR 2)**

- **Reaction to fire: Anchorages satisfy requirements for Class A 1**
- **Resistance to fire: See appendix, especially Annexes C 5 and C 6**

8. Appropriate Technical Documentation and/or Specific Technical Documentation: ---

The performance of the product identified above is in conformity with the set of declared performance/s. This declaration of performance is issued, in accordance with Regulation (EU) No 305/2011, under the sole responsibility of the manufacturer identified above.

Signed for and on behalf of the manufacturer by:

Andreas Bucher, Dipl.-Ing.

Wolfgang Hengesbach, Dipl.-Ing., Dipl.-Wirtsch.-Ing.

Tumlingen, 2018-09-11

- This DoP has been prepared in different languages. In case there is a dispute on the interpretation the english version shall always prevail.
- The Appendix includes voluntary and complementary information in English language exceeding the (language-neutrally specified) legal requirements.

**Specific Part**

**1 Technical description of the product**

The Fischer High-Performance Anchor FH II, FH II-I is an anchor made of galvanised steel (sizes with external diameter 10, 12, 15, 18, 24, 28 and 32, sizes with internal thread 12/M6 I, 12/M8 I, 15/M10 I and 15/M12 I) or stainless steel (sizes with external diameter 10, 12, 15, 18 and 24, sizes with internal thread 12/M6 I, 12/M8 I, 15/M10 I and 15/M12 I) which is placed into a drilled hole and anchored by torque-controlled expansion.

The product description is given in Annex A.

**2 Specification of the intended use in accordance with the applicable European Assessment Document**

The performances given in Section 3 are only valid if the anchor is used in compliance with the specifications and conditions given in Annex B.

The verifications and assessment methods on which this European Technical Assessment is based lead to the assumption of a working life of the anchor of at least 50 years. The indications given on the working life cannot be interpreted as a guarantee given by the producer, but are to be regarded only as a means for choosing the right products in relation to the expected economically reasonable working life of the works.

**3 Performance of the product and references to the methods used for its assessment**

**3.1 Mechanical resistance and stability (BWR 1)**

<b>Essential characteristic</b>	<b>Performance</b>
Characteristic resistance to tension load (static and quasi-static loading)	See Annex C 1 and C 2
Characteristic resistance to shear load (static and quasi-static loading)	See Annex C 3 and C 4
Displacements (static and quasi-static loading)	See Annex C 9 and C 10
Characteristic resistance and displacements for seismic performance categories C1 and C2	See Annex C 7, C 8 and C 10

**3.2 Safety in case of fire (BWR 2)**

<b>Essential characteristics</b>	<b>Performance</b>
Reaction to fire	Class A1
Resistance to fire	See Annex C 5 and C 6

**4 Assessment and verification of constancy of performance (AVCP) system applied, with reference to its legal base**

In accordance with the European Assessment Document EAD 330232-00-0601 the applicable European legal act is: [96/582/EC].

The system to be applied is: 1

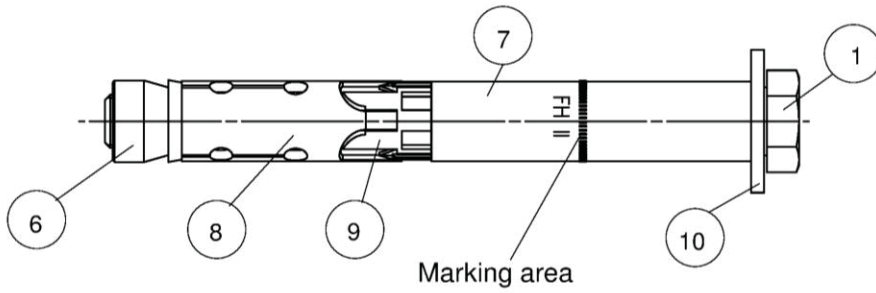

Type hexagon screw **S**  
 FH II 10 - 32 S  
 FH II 10 - 24 S A4

Product label, example:  FH II 15/25 A4

Brand

Type of fastener

Identification A4

Nominal drill hole diameter/max. thickness of fixture ( $t_{fix}$ )

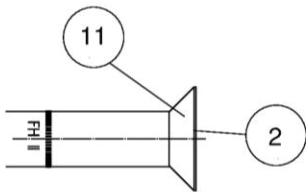

Type countersunk screw **SK**

FH II 10 - 18 SK

FH II 10 - 18 SK A4

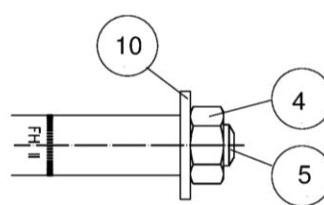

Type hexagon nut **B**

FH II 10 - 32 B

FH II 10 - 24 B A4

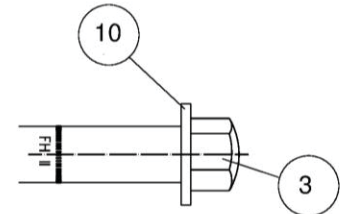

Type cap nut **H**

FH II 10 - 24 H

FH II 10 - 24 H A4

1 Hexagon screw

2 Countersunk screw

3 Cap nut

4 Hexagon nut

5 Threaded rod

6 Cone nut

7 Distance sleeve

8 Expansion sleeve

9 Plastic sleeve

10 Washer

11 Conical washer

12 Internal thread socket

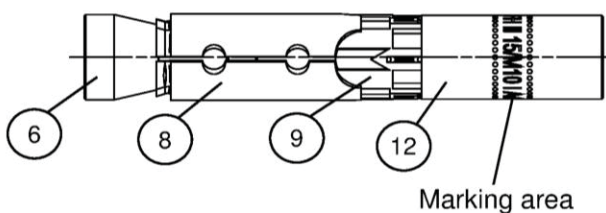

Type internal threaded anchor **I**

FH II 12 M6-I or M8-I

FH II 15 M10-I or M12-I

Product label, example:  FH II 12/M8-I A4

Brand

Type of fastener

Identification A4

Nominal drill hole diameter / size of internal thread

(Fig. not to scaled)

fischer High-Performance Anchor FH II, FH II-I

**Product description**

Anchor types FH II, FH II A4, FH II-I, FH II-I A4

**Annex A 1**

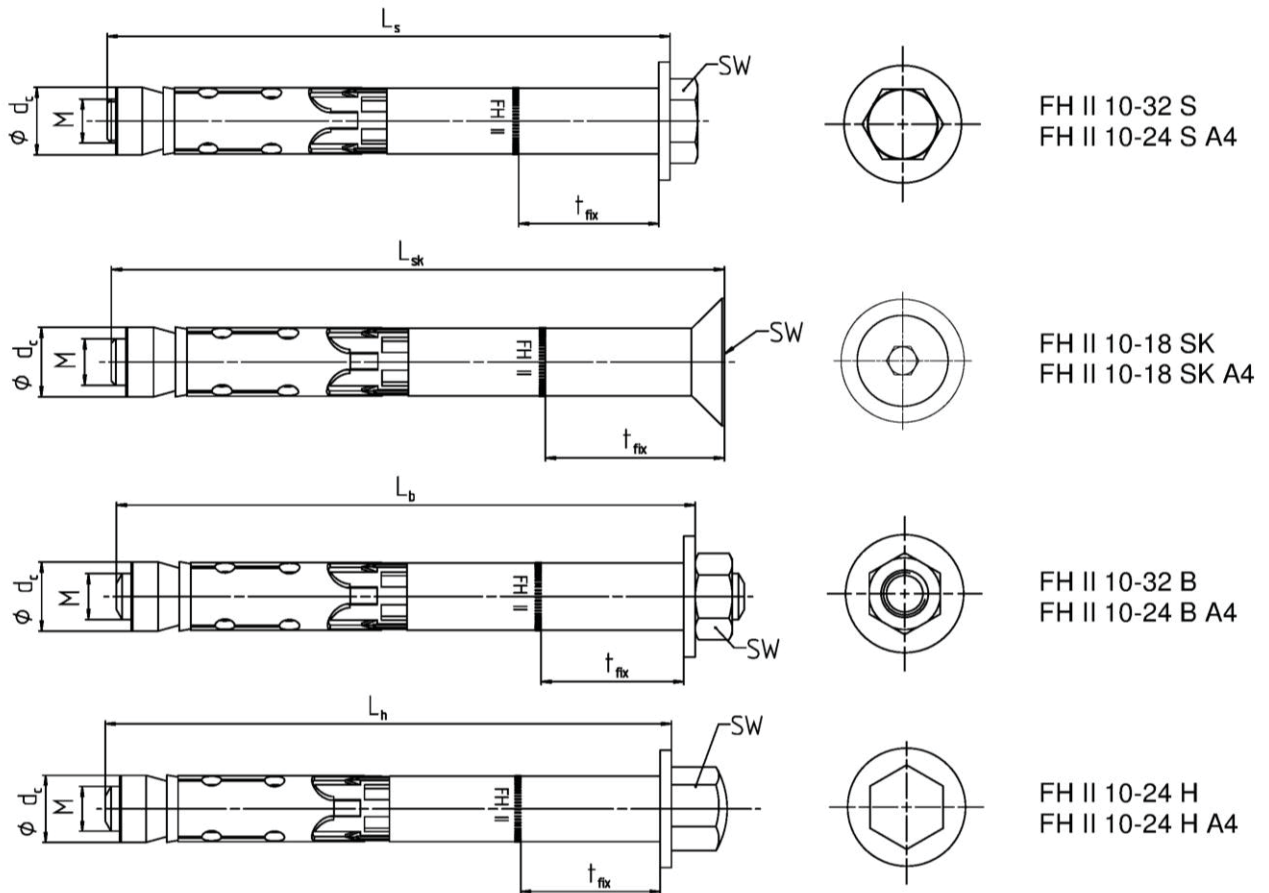

**Table A2.1:** Dimensions [mm] FH II and FH II A4

Anchor type		FH II 10	FH II 12	FH II 15	FH II 18	FH II 24	FH II 28	FH II 32
Thread	M	6	8	10	12	16	20	24
Diameter cone nut	d <sub>c</sub>	10	12	14,8	17,8	23,7	27,5	31,5
Wrench size SW	FH II-S, -B	10	13	17	19	24	30	36
	FH II-SK <sup>1)</sup>	4	5	6	8	-		
	FH II-S, -B	13	17	17	19	24	-	
	FH II-S A4, -B A4, -H A4	10	13	17	19	24	-	
	FH II-SK A4 <sup>1)</sup>	4	5	6	8	-		
t <sub>fix</sub> FH II-S, -B, -H + FH II-S A4, -B A4, -H A4	min	0	0	0	0	0	0	0
t <sub>fix</sub> FH II-SK + FH II-SK A4 <sup>2)</sup>	min	5	6	6	8	-	-	-
Length of screw / bolt	L <sub>s</sub> , L <sub>h</sub> , L <sub>b</sub> (- t <sub>fix</sub> ) ≥	49	74	89	99	124	149	174
Length of countersunk screw	L <sub>sk</sub> (- t <sub>fix</sub> ) ≥	54	79	95	107	-		

<sup>1)</sup> Internal hexagon

<sup>2)</sup> The influence of the thickness of fixture to the characteristic resistance for shear loads, steel failure without lever arm is taken into account, see tables C3.1, C7.1 and C8.1

(Fig. not to scaled)

fischer High-Performance Anchor FH II, FH II-I

**Product description**

Anchor types and dimensions FH II, FH II A4

**Annex A 2**

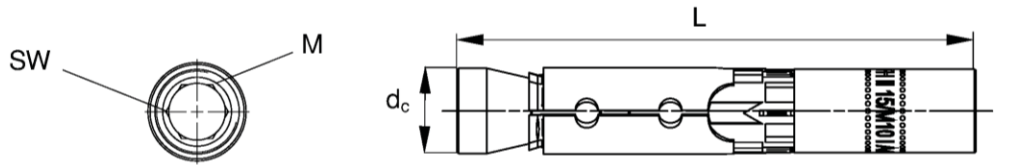

**Table A3.1:** Anchor Dimensions [mm] FH II-I and FH II-I A4

Anchor type FH II-I, FH II-I A4		FH II 12/M6 I	FH II 12/M8 I	FH II 15/M10 I	FH II 15/M12 I
Thread	M	6	8	10	12
Diameter cone nut	d <sub>c</sub>	12	12	14,8	14,8
Wrench size internal hexagon	SW	6	8	6	8
Anchor length	L	77,5	77,5	90	90

**Table A3.2:** Material FH II and FH II A4

No.	Designation	FH II	FH II A4
1	Hexagon screw	Steel class 8.8; EN ISO 898-1:2013 <sup>1)</sup>	Class 80 EN ISO 3506:2010
2	Countersunk screw	Steel class 8.8; EN ISO 898-1:2013 <sup>1)</sup>	
3	Cap nut	Steel class 8 <sup>1)</sup>	
4	Hexagon nut	Steel class 8 <sup>1)</sup>	
5	Threaded rod	Steel f <sub>uk</sub> ≥ 800 N/mm <sup>2</sup> ; f <sub>yk</sub> ≥ 640 N/mm <sup>2</sup> <sup>1)</sup>	Steel f <sub>uk</sub> ≥ 800 N/mm <sup>2</sup> ; f <sub>yk</sub> ≥ 640 N/mm <sup>2</sup>
6	Cone nut	Steel EN 10277:2008 <sup>1)</sup>	Class 80, EN ISO 3506:2010
7	Distance sleeve	Steel EN 10305:2016 <sup>1)</sup>	EN 10088:2014
8	Expansion sleeve	Steel EN 10139:2016/ EN 10277:2008 <sup>1)</sup>	EN 10088:2014
9	Plastic sleeve	ABS (plastic)	
10	Washer	Steel EN 10139:2016 <sup>1)</sup>	EN 10088:2014
11	Conical washer	Steel EN 10277:2008 <sup>1)</sup>	EN 10088:2014

<sup>1)</sup> Galvanised according to EN ISO 4042:2001, ≥ 5 µm

**Table A3.3:** Material FH II-I and FH II-I A4

No.	Designation	FH II-I	FH II-I A4
6	Cone nut	Steel EN 10277:2008 <sup>1)</sup>	Strength class ≥ 70 EN ISO 3506:2010
8	Expansion sleeve	Steel EN 10139:2016 / EN 10277:2008 <sup>1)</sup>	EN 10088:2014
9	Plastic sleeve	ABS (plastic)	
12	Internal thread bolt	Steel EN 10277:2008 <sup>1)</sup> f <sub>uk</sub> ≥ 750 N/mm <sup>2</sup> , f <sub>yk</sub> ≥ 600 N/mm <sup>2</sup>	EN 10088:2014 f <sub>uk</sub> ≥ 750 N/mm <sup>2</sup> , f <sub>yk</sub> ≥ 600 N/mm <sup>2</sup>
Requirements for fixing elements		Steel strength class 5.8, 6.8 or 8.8 EN ISO 898-1:2013 <sup>1)</sup>	Steel strength class A50, A70 or A80 EN ISO 3506:2010 1.4362, 1.4401, 1.4404, 1.4571, 1.4529

<sup>1)</sup> Galvanised according to EN ISO 4042:2001, ≥ 5 µm

fischer High-Performance Anchor FH II, FH II-I	<b>Annex A 3</b>
<b>Product description</b> Anchor types and dimensions FH II-I, FH II I-A4 Materials	

<b>Specifications of intended use</b>								
<b>Anchorage subject to:</b>								
Size		10	12	15	18	24	28	32
High Performance Anchor	FH II							
	FH II A4			✓				-
High Performance Anchor FH II-I, FH II-I A4		-	✓					-
Static and quasi-static loads								
Cracked and uncracked concrete					✓			
Fire exposure								
Seismic performance category	C1 FH II					✓		
	C1 FH II A4			✓				-
	C2 FH II					✓		
	C2 FH II A4			✓				-

**Base materials:**

- Compacted reinforced or unreinforced normal weight concrete without fibres (cracked or uncracked) according to EN 206:2013
- Strength classes C20/25 to C50/60 according to EN 206-1:2013

**Use conditions (Environmental conditions):**

- Structures subject to dry internal conditions (FH II, FH II A4, FH II-I, FH II-I A4)
- Structures subject to external atmospheric exposure (including industrial and marine environment) and to permanently damp internal conditions, if no particular aggressive conditions exist (FH II A4, FH II-I A4)

Note: Particular aggressive conditions are e.g. permanent, alternating immersion in seawater or the splash zone of seawater, chloride atmosphere of indoor swimming pools or atmosphere with extreme chemical pollution (e.g. in desulphurization plants or road tunnels where de-icing materials are used)

**Design:**

- Anchorages are to be designed under the responsibility of an engineer experienced in anchorages and concrete work
- Verifiable calculation notes and drawings are to be prepared taking account of the loads to be anchored. The position of the anchor is indicated on the design drawings (e.g. position of the anchor relative to reinforcement or to supports, etc.)
- Design of fastenings according to FprEN 1992-4: 2016 and EOTA Technical Report TR 055

**Installation:**

- Anchor installation carried out by appropriately qualified personnel and under the supervision of the person responsible for technical matters of the site
- Hammer or hollow drilling according to Annex B5 and B6
- In case of aborted hole: New hole must be drilled at a minimum distance of twice the depth of the aborted hole or closer, if the hole is filled with a high strength mortar and only if the hole is not in the direction of the oblique tensile or shear load

fischer High-Performance Anchor FH II, FH II-I	<b>Annex B 1</b>
<b>Intended use Specifications</b>	

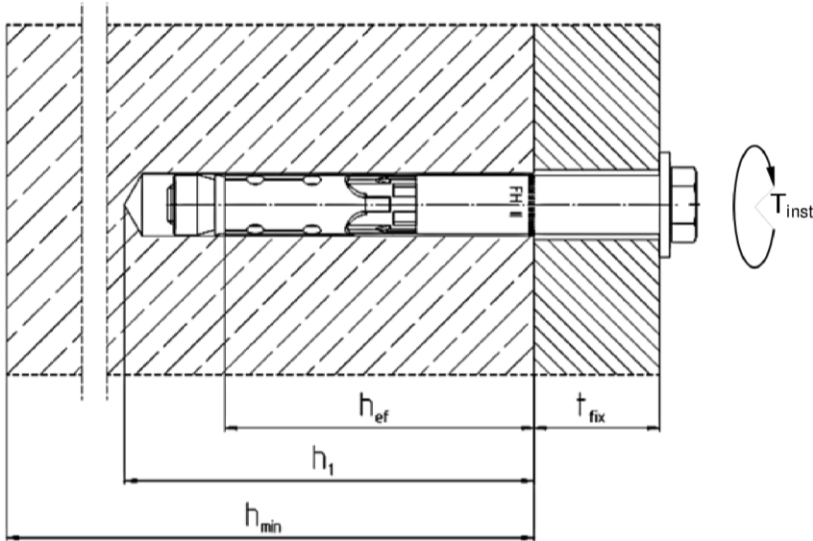

- $h_{ef}$  = Effective embedment depth
- $t_{fix}$  = Thickness of the fixture
- $h_1$  = Depth of drill hole to deepest point
- $h_{min}$  = Minimum thickness of concrete member
- $T_{inst}$  = Required setting torque

**Table B2.1:** Installation parameters FH II and FH II A4

Anchor type FH II-S,-SK,-B,-H and FH II-S A4, FH II-SK A4, FH II-B A4, FH II H A4	FH II 10	FH II 12	FH II 15	FH II 18	FH II 24	FH II 28	FH II 32	
Nominal drill hole diameter $d_0$	10	12	15	18	24	28	32	
Maximum diameter of drill bit $d_{cut} \leq$	10,45	12,50	15,50	18,50	24,55	28,55	32,70	
Depth of drill hole to deepest $h_1 \geq$	55	80	90	105	125	155	180	
Diameter of clearance hole $d_f \leq$	12	14	17	20	26	31	35	
Diameter of counter sunk FH II-SK	18	22	25	32	-			
Depth of counter sunk, 90° FH II-SK A4	5,0	5,8	5,8	8,0				
Required setting torque $T_{inst}$ [Nm]	10	FH II-S	22,5	40	80	160	180	200
		FH II-B	17,5	38		120	180	200
		FH II-H	22,5	40		90	-	
	FH II-SK	-						
	15	25	40	100	160	-		
	10				-			

fischer High-Performance Anchor FH II, FH II-I

**Intended use**  
Installation parameters FH II, FH II A4

**Annex B 2**



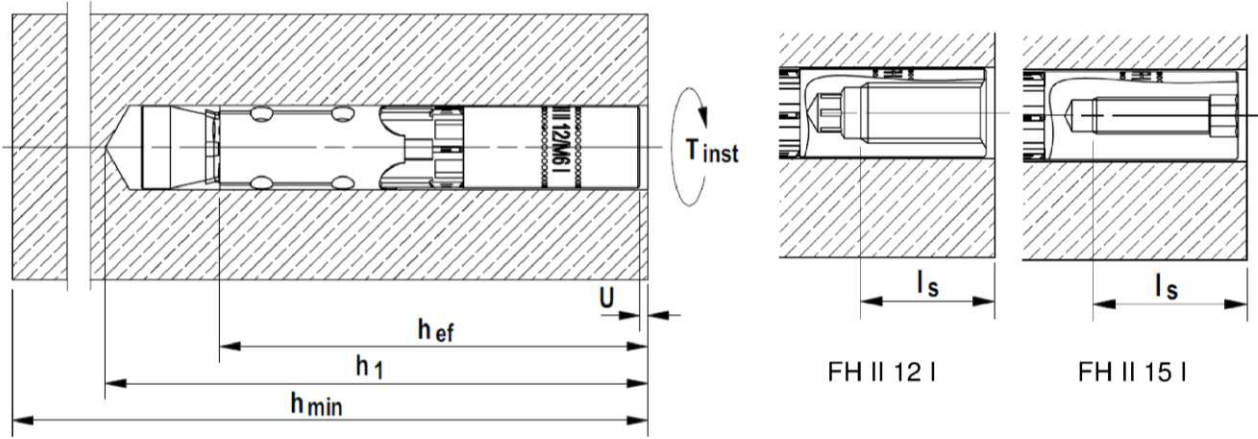

- $h_{ef}$  = Effective embedment depth
- $h_1$  = Depth of drill hole to deepest point
- $h_{min}$  = Minimum thickness of concrete member
- $T_{inst}$  = Required setting torque
- $U$  = Required gap after torquing
- $l_s$  = Screw-in depth

**Table B3.1:** Installation parameters FH II-I and FH II-I A4

Anchor type FH II-I and FH II-I A4		FH II 12/M6 I	FH II 12/M8 I	FH II 15/M10 I	FH II 15/M12 I
Nominal drill hole diameter	$d_0$	12		15	
Maximum bit diameter	$d_{cut} \leq$	12,50		15,50	
Depth of drill hole	$h_1 \geq$ [mm]	85		95	
Diameter of clearance hole	$d_f \leq$	7	9	12	14
Required gap after torquing <sup>1)</sup>	$U$	3 - 5			
Required setting torque <sup>1)</sup>	$T_{inst}$ [Nm]	15		25	
Minimum screw-in depth	$l_s \geq$	11 + U	13 + U	10 + U	12 + U
Maximum screw-in depth	$l_s \leq$	20 + U			
Maximum torque on fixture in combination with screws and threaded rods strength class $\geq 5.8$ resp. $\geq A50$	$\max T_{fix}$ [Nm]	3	8	15	20

<sup>1)</sup> At least one of the requirements concerning the gap  $U$  or the required setting torque  $T_{inst}$  have to be fulfilled

fischer High-Performance Anchor FH II, FH II-I

**Intended use**  
Installation parameters FH II-I, FH II-I A4

**Annex B 3**

**Table B4.1:** Minimum thickness of concrete member, minimum spacing and minimum edge distances  
FH II, FH II A4

Anchor type FH II-S,-SK,-B,-H and FH II-S A4,-SK A4,-B A4,-H A4		FH II 10	FH II 12	FH II 15	FH II 18	FH II 24	FH II 28	FH II 32
Minimum thickness of concrete member	$h_{min}$ [mm]	80	120	140	160	200	250	300
Minimum spacing, cracked concrete	$s_{min}$	40	50	60	70	80	100	120
	for $c \geq$	40	80	120	140	180	200	260
Minimum edge distance, cracked concrete	$c_{min}$	40	50	60	70	80	100	120
	for $s \geq$	40	80	120	160	200	220	280
Minimum spacing, uncracked concrete	$s_{min}$	40	60	70	80	100	120	160
	for $c \geq$	70	100	100	160	200	220	360
Minimum edge distance, uncracked concrete	$c_{min}$	40	60	70	80	100	120	180
	for $s \geq$	70	100	140	200	220	240	380

Intermediate values may be calculated by linear interpolation

**Table B4.2:** Minimum thickness of concrete member, minimum spacing and minimum edge distances  
FH II-I, FH II-I A4

Anchor type FH II-I and FH II-I A4		FH II 12/M6 I FH II 12/M8 I	FH II 15/M10 I FH II 15/M12 I
Minimum thickness of concrete member	$h_{min}$ [mm]	125	150
Minimum spacing, cracked concrete	$s_{min}$	50	60
	for $c \geq$	80	120
Minimum edge distance, cracked concrete	$c_{min}$	50	60
	for $s \geq$	80	120
Minimum spacing, uncracked concrete	$s_{min}$	60	70
	for $c \geq$	100	100
Minimum edge distance, uncracked concrete	$c_{min}$	60	70
	for $s \geq$	100	140

Intermediate values may be calculated by linear interpolation.

**Table B4.3:** Minimum spacings and minimum edge distances of anchors under **fire exposure** for  
tension and shear loads

Anchor type	FH II 10	FH II 12 FH II 12-I	FH II 15 FH II 15-I	FH II 18	FH II 24	FH II 28	FH II 32
Spacing $\frac{s_{cr,N,fi}}{s_{min,fi}}$	$4 \times h_{ef}$						
	40	50	60	70	80	100	120
Edge distance $\frac{c_{cr,N,fi}}{c_{min,fi}}$ [mm]	$2 \times h_{ef}$						
	$c_{min,fi} = 2 \times h_{ef}$ , for fire exposure from more than one side $c_{min,fi} \geq 300$ mm						

fischer High-Performance Anchor FH II, FH II-I

**Intended use**  
Minimum thickness of concrete member, minimum spacings and min. edge distances  
Minimum spacings and minimum edge distances of anchors under fire exposure

**Annex B 4**

Installation instruction for the fischer High-Performance anchor  
**FH II 10 - FH II 32 and FH II 10 A4 - FH II 24 A4**

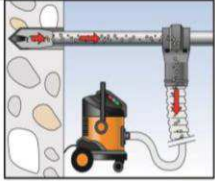
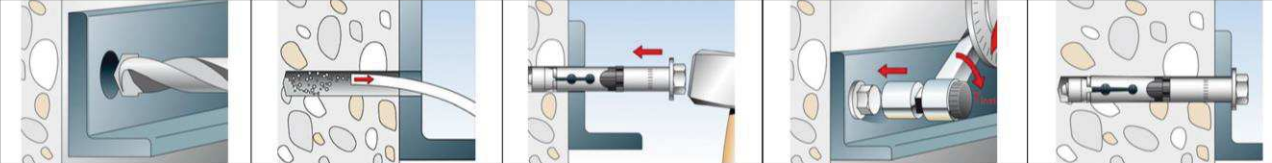
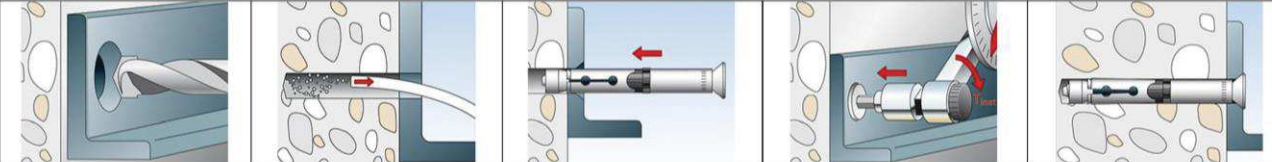
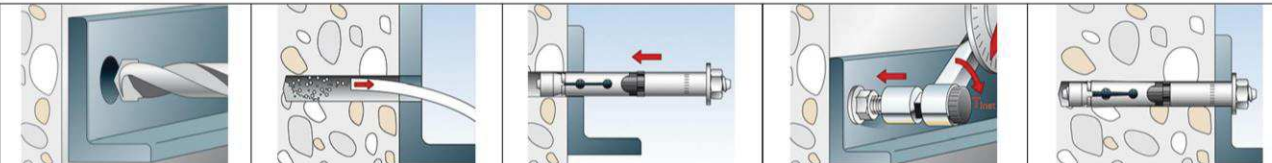
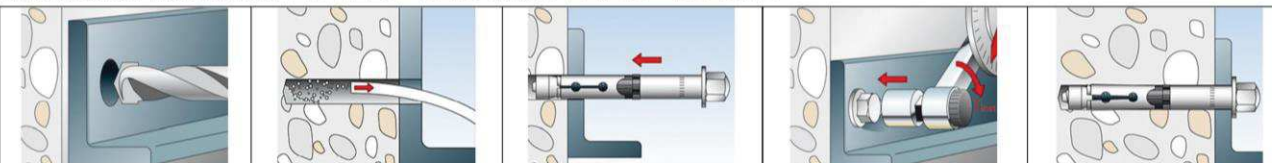
<b>Hollow drilling</b>		Continue with step 3, 4 and 5			
	 <p>Installation instruction FH II 10 - 32 S and FH II 10 - 24 S A4</p>				
<b>Hammer drilling</b>	 <p>Installation instruction FH II 10 - 18 SK and FH II 10 - 18 SK A4</p>				
	 <p>Installation instruction FH II 10 - 32 B and FH II 10 - 24 B A4</p>				
 <p>Installation instruction FH II 10 - 24 H and FH II 10 - 24 H A4</p>					
Step	<b>1</b>	<b>2</b>	<b>3</b>	<b>4</b>	<b>5</b>

Step	Description	
1	Create drill hole with hammer drill	Create drill hole with hollow drill and vacuum cleaner
2	Clean the hole	-
3	Set the fastener	
4	Apply $T_{inst}$	
5	Installed fastener	

Types of drill bits

Hammer drill



Hollow drill



fischer High-Performance Anchor FH II, FH II-I

**Intended use**  
 Installation instructions FH II, FH II A4

**Annex B 5**

Installation instruction for the fischer High-Performance anchor internal thread  
**FH II-I and FH II-I A4**

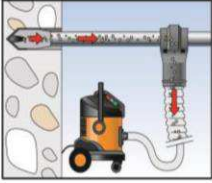
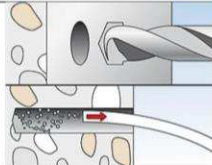
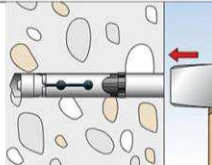
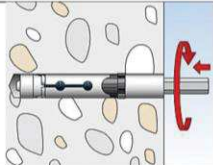
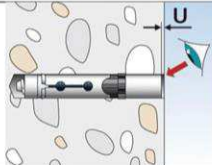
<b>Hollow drilling</b>		Continue with step 2, 3, and 4		
<b>Hammer drilling</b>				
Step	1	2	3	4

Step	Description
1	<p>Create drill hole with hammer drill, clean drill hole</p> <p style="text-align: right;">Create drill hole with hollow drill and vacuum cleaner</p>
2	Hammering in the anchor flushed with the surface of the concrete
3	<p>Tighten the anchor. The included hexagon bit in the package should be used. Other tightening methods are allowed.</p> <p>Tighten the anchor in the concrete until the gap U is 3 - 5 mm or the required setting torque <math>T_{inst}</math> is reached. Only one of the above requirements has to be fulfilled.</p>
4	<p>Attach the fixture and use a suitable screw or anchor rod. The length of the screw or anchor rod should be determined depending on the thickness of fixture <math>t_{fix}</math>, admissible tolerances, and available thread length <math>l_{s,max}</math> and <math>l_{s,min}</math> including the gap U.</p> <p>Tighten the screw with the torque <math>\leq \max T_{fix}</math> (<math>\max T_{fix}</math> see table B3.1)</p>

Types of drill bits

Hammer drill



Hollow drill



fischer High-Performance Anchor FH II, FH II-I

**Intended use**  
 Installation instructions FH II-I, FH II-I A4

**Annex B 6**

<b>Table C1.1: Performance characteristics of tension resistance under static and quasi-static loads for FH II and FH II A4</b>									
Anchor type FH II-S,-SK,-B,-H and FH II-S A4,-SK A4,-B A4,-H A4			<b>FH II 10</b>	<b>FH II 12</b>	<b>FH II 15</b>	<b>FH II 18</b>	<b>FH II 24</b>	<b>FH II 28<sup>3)</sup></b>	<b>FH II 32<sup>3)</sup></b>
<b>Steel failure</b>									
FH II	$N_{Rk,s}$	[kN]	16,1	29,3	46,4	67,4	125,3	195,8	282,0
FH II A4-B, -H	$N_{Rk,s}$	[kN]	16,1	29,3	46,4	67,4	125,3	-	
Partial factor for steel failure	$\gamma_{Ms}$ <sup>1)</sup>	[-]	1,5						
FH II A4-S,-SK	$N_{Rk,s}$	[kN]	16,1	29,3	46,4	67,4	125,3	-	
Partial factor for steel failure	$\gamma_{Ms}$ <sup>1)</sup>	[-]	1,6						
<b>Pullout failure</b>									
Characteristic resistance in cracked concrete C20/25 FH II and FH II A4			7,5	12	16	25	2)		
Characteristic resistance in uncracked concrete C20/25 FH II	$N_{Rk,p}$	[kN]	2)						
Characteristic resistance in uncracked concrete C20/25 FH II A4			2)	20	2)			-	
Increasing factors for $N_{Rk,p}$ for cracked and uncracked concrete	$\psi_c$	C25/30	1,12						
		C30/37	1,22						
		C35/45	1,32						
		C40/50	1,41						
		C45/55	1,50						
		C50/60	1,58						
Robustness factor	$\gamma_{inst}$	[-]	1,0						
<b>Concrete cone failure and splitting failure</b>									
Effective embedment depth	$h_{ef}$	[mm]	40	60	70	80	100	125	150
Factor for cracked concrete	$k_{cr,N}$	[-]	7,7 <sup>4)</sup>						
Factor for uncracked concrete	$k_{ucr,N}$		11,0 <sup>4)</sup>						
Spacing	$s_{cr,N}$	[mm]	120	180	210	240	300	375	450
Edge distance	$c_{cr,N}$		60	90	105	120	150	187,5	225
Spacing (splitting)	$s_{cr,sp}$		190	300	320	340	380	480	570
Edge distance (splitting)	$c_{cr,sp}$		95	150	160	170	190	240	285
<sup>1)</sup> In absence of other national regulations <sup>2)</sup> Pullout failure not relevant <sup>3)</sup> Only valid for zinc-plated version <sup>4)</sup> Based on concrete strength as cylinder strength									
fischer High-Performance Anchor FH II, FH II-I							<b>Annex C 1</b>		
<b>Performances</b> Performance characteristics of tension resistance for FH II and FH II A4									

<b>Table C2.1: Performance characteristics of tension resistance under static and quasi-static loads for FH II-I and FH II-I A4</b>					
Anchor type FH II-I and FH II-I A4		<b>FH II 12/M6 I</b>	<b>FH II 12/M8 I</b>	<b>FH II 15/M10 I</b>	<b>FH II 15/M12 I</b>
<b>Steel failure</b>					
<b>Anchor in combination with screw / threaded rod of galvanised steel complying with DIN EN ISO 898</b>					
Strength class 5.8	$N_{Rk,s}$ [kN]	10	19	29	43
Strength class 6.8		12	23	35	44
Strength class 8.8		16	27	44	44
Partial factor for steel failure	$\gamma_{Ms}^{1)}$ [-]	1,5			
<b>Anchor in combination with screw / threaded rod of stainless steel complying with DIN EN ISO 3506</b>					
Screw/thread strength class A50	$N_{Rk,s}$ [kN]	10	19	29	43
Partial factor for steel failure	$\gamma_{Ms}^{1)}$ [-]	2,86			
Screw/thread strength class A70	$N_{Rk,s}$ [kN]	14	26	41	54
Partial factor for steel failure	$\gamma_{Ms}^{1)}$ [-]	1,87			
Screw/thread strength class A80	$N_{Rk,s}$ [kN]	16	29	46	46
Partial factor for steel failure	$\gamma_{Ms}^{1)}$ [-]	1,60			
<b>Pullout failure</b>					
Characteristic resistance in cracked concrete C20/25	$N_{Rk,p}$ [kN]	9		12	
Characteristic resistance in uncracked concrete C20/25		20		2)	
Increasing factors for $N_{Rk,p}$ for cracked and uncracked concrete	$\psi_c$	C25/30	1,12		
		C30/37	1,22		
		C35/45	1,32		
		C40/50	1,41		
		C45/55	1,50		
		C50/60	1,58		
Robustness factor	$\gamma_{inst}$ [-]	1,0			
<b>Concrete cone failure and splitting failure</b>					
Effective embedment depth	$h_{ef}$ [mm]	60		70	
Factor for cracked concrete	$k_{cr,N}$	7,7 <sup>3)</sup>			
Factor for uncracked concrete	$k_{ucr,N}$	11,0 <sup>3)</sup>			
Spacing	$s_{cr,N}$	180		210	
Edge distance	$c_{cr,N}$	90		105	
Spacing (splitting)	$s_{cr,sp}$	300		320	
Edge distance (splitting)	$c_{cr,sp}$	150		160	
<sup>1)</sup> In absence of other national regulations <sup>2)</sup> Pullout failure is not decisive <sup>3)</sup> Based on concrete strength as cylinder strength					
fischer High-Performance Anchor FH II, FH II-I					<b>Annex C 2</b>
<b>Performances</b> Performance characteristics of tension resistance for FH II-I and FH II-I A4					

<b>Table C3.1: Performance characteristics of shear resistance for FH II and FH II A4 under static and quasi-static loads</b>								
Anchor type FH II-S, -SK, -B, -H and FH II-S A4, -SK A4, -B A4, -H A4		FH II 10	FH II 12	FH II 15	FH II 18	FH II 24	FH II 28 <sup>3)</sup>	FH II 32 <sup>3)</sup>
<b>Steel failure without lever arm</b>								
FH II-S,	$V_{Rk,s}^0$ [kN]	18,0	33,0	59,0	76,0	146,0	176,4	217,0
FH II-B,-H		16,0	27,2	42,8	61,9	119,0	148,8	169,0
FH II-SK	$t_{fix}^{2)}$ [mm]	≥ 10		≥ 15		-		
	$V_{Rk,s}^0$ [kN]	18,0	33,0	59,0	76,0			
	$t_{fix}^{2)}$ [mm]	< 10		< 15				
	$V_{Rk,s}^0$ [kN]	8,0	14,0	23,0	34,0			
Partial factor for steel failure	$\gamma_{Ms}^{1)}$ [-]	1,25						
Factor for ductility	$k_7$	1,0						
FH II-S A4	$V_{Rk,s}^0$ [kN]	18,0	33,0	59,0	76,0	146,0	-	
Partial factor for steel failure	$\gamma_{Ms}^{1)}$ [-]	1,33						
FH II-B A4,-H A4	$V_{Rk,s}^0$ [kN]	16,0	27,2	42,8	61,9	119,0	-	
Partial factor for steel failure	$\gamma_{Ms}^{1)}$ [-]	1,25						
FH II-SK A4	$t_{fix}^{2)}$ [mm]	≥ 10		≥ 15		-		
	$V_{Rk,s}^0$ [kN]	18,0	33,0	59,0	76,0			
	$t_{fix}^{2)}$ [mm]	< 10		< 15				
	$V_{Rk,s}^0$ [kN]	8,0	14,0	23,0	34,0			
Partial factor for steel failure	$\gamma_{Ms}^{1)}$ [-]	1,33						
Factor for ductility	$k_7$	1,0						
<b>Steel failure with lever arm and concrete pryout failure</b>								
Characteristic bending resistance FH II	$M_{Rk,s}^0$ [Nm]	12	30	60	105	266	518	896
Partial factor for steel failure	$\gamma_{Ms}^{1)}$ [-]	1,25						
Characteristic bending resistance FH II A4	$M_{Rk,s}^0$ [Nm]	12	30	60	105	266	-	
Partial factor for steel failure -B,-H	$\gamma_{Ms}^{1)}$ [-]	1,25						
Partial factor for steel failure -S,-SK	$\gamma_{Ms}^{1)}$ [-]	1,33						
Factor for pryout failure	$k_8$ [-]	1,0	2,0					
<b>Concrete edge failure</b>								
Effective embedment depth for calculation	$l_f =$	$h_{ef}$						
	[mm]							
Outside diameter of a fastener	$d_{nom}$	10	12	15	18	24	28	32
<sup>1)</sup> In absence of other national regulations <sup>2)</sup> The thickness of the fixture has influence to the characteristic resistance for shear loads, steel failure without lever arm <sup>3)</sup> Only valid for zinc-plated version								
fischer High-Performance Anchor FH II, FH II-I						<b>Annex C 3</b>		
<b>Performances</b> Performance characteristics of shear resistance for FH II and FH II A4								

<b>Table C4.1: Performance characteristics of shear resistance for FH II-I and FH II-I A4 under static and quasi-static loads</b>					
Anchor type FH II-I and FH II-I A4		<b>FH II 12/M6 I</b>	<b>FH II 12/M8 I</b>	<b>FH II 15/M10 I</b>	<b>FH II 15/M12 I</b>
<b>Steel failure without lever arm</b>					
<b>Anchor in combination with screw / threaded rod of galvanised steel complying with DIN EN ISO 898:2013</b>					
Strength class 5.8		5	9	15	21
Strength class 6.8	$V_{Rk,s}^0$ [kN]	6	11	18	24
Strength class 8.8		8	14	23	24
Partial factor for steel failure	$\gamma_{Ms}^{1)}$ [-]	1,25			
Factor for ductility	$k_7$	1,0			
<b>Anchor in combination with screw / threaded rod of stainless steel complying with DIN EN ISO 3506:2010</b>					
Strength class A50	$V_{Rk,s}^0$ [kN]	5	9	15	21
Partial factor for steel failure	$\gamma_{Ms}^{1)}$ [-]	2,38			
Strength class A70	$V_{Rk,s}^0$ [kN]	7	13	20	30
Partial factor for steel failure	$\gamma_{Ms}^{1)}$ [-]	1,56			
Strength class A80	$V_{Rk,s}^0$ [kN]	8	15	23	32
Partial factor for steel failure	$\gamma_{Ms}^{1)}$ [-]	1,33			
Factor for ductility	$k_7$	1,0			
<b>Steel failure with lever arm and concrete pryout failure</b>					
<b>Anchor in combination with screw / threaded rod of galvanised steel complying with DIN EN ISO 898:2013</b>					
Strength class 5.8		8	19	37	65
Strength class 6.8	$M_{Rk,s}^0$ [Nm]	9	23	44	78
Strength class 8.8		12	30	60	105
Partial factor for steel failure	$\gamma_{Ms}^{1)}$ [-]	1,25			
Factor for ductility	$k_7$	1,0			
<b>Anchor in combination with screw / threaded rod of stainless steel complying with DIN EN ISO 3506:2010</b>					
Strength class A50	$M_{Rk,s}^0$ [Nm]	8	19	37	65
Partial factor for steel failure	$\gamma_{Ms}^{1)}$ [-]	2,38			
Strength class A70	$M_{Rk,s}^0$ [Nm]	11	26	52	92
Partial factor for steel failure	$\gamma_{Ms}^{1)}$ [-]	1,56			
Strength class A80	$M_{Rk,s}^0$ [Nm]	12	30	60	105
Partial factor for steel failure	$\gamma_{Ms}^{1)}$ [-]	1,33			
Factor for ductility	$k_7$ [-]	1,0			
Factor for pryout failure	$k_8$	2,0			
<b>Concrete edge failure</b>					
Effective embedment depth for calculation	$l_f =$ [mm]	$h_{ef}$			
Outside diameter of fastener	$d_{nom}$	12		15	
<sup>1)</sup> In absence of other national regulations					
fischer High-Performance Anchor FH II, FH II-I					<b>Annex C 4</b>
<b>Performances</b> Performance characteristics of shear resistance for FH II-I and FH II-I A4					



**Table C5.1: Performance characteristics of tension resistance under fire exposure**

Anchor type	R30			R60		
	$N_{Rk,s,fi,30}$ [kN]	$N_{Rk,p,fi,30}$ [kN]	$N^0_{Rk,c,fi,30}$ [kN]	$N_{Rk,s,fi,60}$ [kN]	$N_{Rk,p,fi,60}$ [kN]	$N^0_{Rk,c,fi,60}$ [kN]
FH II 10, FH II 10 A4	0,2	1,8	1,8	0,2	1,8	1,8
FH II 12, FH II 12 A4	2,0	3,0	5,0	1,3	3,0	5,0
FH II 15, FH II 15 A4	3,2	4,0	7,4	2,3	4,0	7,4
FH II 18, FH II 18 A4	4,8	6,3	10,3	3,9	6,3	10,3
FH II 24, FH II 24 A4	8,9	9,0	18,0	7,3	9,0	18,0
FH II 28	13,9	12,6	31,4	11,3	12,6	31,4
FH II 32	20,0	16,5	49,6	16,3	16,5	49,6
FH II 12/M6-I, 5.8, A50 <sup>1)</sup>	0,1	2,3	5,0	0,1	2,3	5,0
FH II 12/M6-I A4 8.8, A70, A80 <sup>1) 2)</sup>	0,2			0,2		
FH II 12/M8-I, 5.8, A50 <sup>1)</sup>	1,3			0,8		
FH II 12/M8-I A4 8.8, A70, A80 <sup>1) 2)</sup>	2,0			1,3		
FH II 15/M10-I, 5.8, A50 <sup>1)</sup>	2,0	3,0	7,4	1,4	3,0	7,4
FH II 15/M10-I A4 8.8, A70, A80 <sup>1) 2)</sup>	3,2			2,3		
FH II 15/M12-I, 5.8/A50 <sup>1)</sup>	3,0			2,4		
FH II 15/M12-I A4 8.8, A70, A80 <sup>1) 2)</sup>	4,8			3,9		
Anchor type	R90			R120		
	$N_{Rk,s,fi,90}$ [kN]	$N_{Rk,p,fi,90}$ [kN]	$N^0_{Rk,c,fi,90}$ [kN]	$N_{Rk,s,fi,120}$ [kN]	$N_{Rk,p,fi,120}$ [kN]	$N^0_{Rk,c,fi,120}$ [kN]
FH II 10, FH II 10 A4	0,1	1,8	1,8	0,1	1,5	1,5
FH II 12, FH II 12 A4	0,6	3,0	5,0	0,2	2,4	4,0
FH II 15, FH II 15 A4	1,4	4,0	7,4	1,0	3,2	5,9
FH II 18, FH II 18 A4	3,0	6,3	10,3	2,6	5,0	8,2
FH II 24, FH II 24 A4	5,6	9,0	18,0	4,8	7,2	14,4
FH II 28	8,8	12,6	31,4	7,5	10,1	25,2
FH II 32	12,6	16,5	49,6	10,8	13,2	39,7
FH II 12/M6-I, 5.8, A50 <sup>1)</sup>	0,1	2,3	5,0	0,1	1,8	4,0
FH II 12/M6-I A4 8.8, A70, A80 <sup>1) 2)</sup>	0,1			0,1		
FH II 12/M8-I, 5.8, A50 <sup>1)</sup>	0,4			0,1		
FH II 12/M8-I A4 8.8, A70, A80 <sup>1) 2)</sup>	0,6			0,2		
FH II 15/M10-I, 5.8, A50 <sup>1)</sup>	0,9	3,0	7,4	0,6	2,4	5,9
FH II 15/M10-I A4 8.8, A70, A80 <sup>1) 2)</sup>	1,4			1,0		
FH II 15/M12-I, 5.8/A50 <sup>1)</sup>	1,9			1,6		
FH II 15/M12-I A4 8.8, A70, A80 <sup>1) 2)</sup>	3,0			2,6		

<sup>1)</sup> Intermediate values by linear interpolation  
<sup>2)</sup> In combination with screw / threaded rod strength class 8.8, A70, A80

In absence of other national regulations the partial safety factor for resistance under fire exposure  $\gamma_{M,fi} = 1,0$  is recommended

**Table C6.1: Performance characteristics of shear resistance under fire exposure**

Anchor type	R30		R60	
	$V_{Rk,s,fi,30}$ [kN]	$M_{Rk,s,fi,30}^0$ [Nm]	$V_{Rk,s,fi,60}$ [kN]	$M_{Rk,s,fi,60}^0$ [Nm]
FH II 10, FH II 10 A4	0,3	0	0,3	0
FH II 12, FH II 12 A4	2,0	2	1,3	1
FH II 15, FH II 15 A4	3,2	4	2,3	3
FH II 18, FH II 18 A4	4,8	7	3,9	6
FH II 24, FH II 24 A4	8,9	19	7,3	15
FH II 28	13,9	37	11,3	30
FH II 32	20,0	64	16,3	52
FH II 12/M6 I, 5.8, A50 <sup>1)</sup>	0,2	0	0,2	0
FH II 12/M6 I A4 8.8, A70, A80 <sup>1) 2)</sup>	0,3	0	0,3	0
FH II 12/M8 I, 5.8, A50 <sup>1)</sup>	1,3	1	0,8	1
FH II 12/M8-I A4 8.8, A70, A80 <sup>1) 2)</sup>	2,0	2	1,3	1
FH II 15/M10 I, 5.8, A50 <sup>1)</sup>	2,0	3	1,4	2
FH II 15/M10-I A4 8.8, A70, A80 <sup>1) 2)</sup>	3,2	4	2,3	3
FH II 15/M12-I, 5.8/A50 <sup>1)</sup>	3,0	4	2,4	4
FH II 15/M12-I A4 8.8, A70, A80 <sup>1) 2)</sup>	4,8	7	3,9	6
Anchor type	R90		R120	
	$V_{Rk,s,fi,90}$ [kN]	$M_{Rk,s,fi,90}^0$ [Nm]	$V_{Rk,s,fi,120}$ [kN]	$M_{Rk,s,fi,120}^0$ [Nm]
FH II 10, FH II 10 A4	0,2	0	0,1	0
FH II 12, FH II 12 A4	0,6	1	0,2	0
FH II 15, FH II 15 A4	1,4	2	1,0	1
FH II 18, FH II 18 A4	3,0	5	2,6	4
FH II 24, FH II 24 A4	5,6	12	4,8	10
FH II 28	8,8	23	7,5	20
FH II 32	12,6	40	10,8	34
FH II 12/M6-I, 5.8, A50 <sup>1)</sup>	0,1	0	0,1	0
FH II 12/M6-I A4 8.8, A70, A80 <sup>1) 2)</sup>	0,2	0	0,1	0
FH II 12/M8-I, 5.8, A50 <sup>1)</sup>	0,4	1	0,1	0
FH II 12/M8-I A4 8.8, A70, A80 <sup>1) 2)</sup>	0,6	1	0,2	0
FH II 15/M10 I, 5.8, A50 <sup>1)</sup>	0,9	2	0,6	1
FH II 15/M10-I A4 8.8, A70, A80 <sup>1) 2)</sup>	1,4	3	1,0	1
FH II 15/M12 I, 5.8/A50 <sup>1)</sup>	1,9	4	1,6	3
FH II 15/M12-I A4 8.8, A70, A80 <sup>1) 2)</sup>	3,0	6	2,6	4

<sup>1)</sup> Intermediate values by linear interpolation

<sup>2)</sup> In combination with screw / threaded rod strength class 8.8, A70, A80

In absence of other national regulations the partial safety factor for resistance under fire exposure

$\gamma_{M,fi} = 1,0$  is recommended

fischer High-Performance Anchor FH II, FH II-I

**Performances**

Performance characteristics of shear resistance under fire exposure

**Annex C 6**

**Table C7.1:** Performance characteristics of **tension and shear resistance** for **seismic performance category C1** for FH II-S,-SK,-B,-H and FH II-S A4,-SK A4,-B A4,-H A4

Anchor type FH II-S,-SK,-B,-H and FH II-S A4,-SK A4,-B A4,-H A4				FH II 12	FH II 15	FH II 18	FH II 24	FH II 28 <sup>3)</sup>	FH II 32 <sup>3)</sup>	
<b>Steel failure</b>										
Characteristic resistance of tension load C1	FH II-S,-SK,-B,-H -B A4, -H A4	$N_{Rk,s,C1}$ [kN]		29,3	46,4	67,4	125,3	195,8	282,0	
		$\gamma_{Ms,C1}^{1)}$ [-]		1,5						
	FH II-S A4,-SK A4 -B A4, -H A4	$N_{Rk,s,C1}$ [kN]		29,3	46,4	67,4	125,3	-		
		$\gamma_{Ms,C1}^{1)}$ [-]		1,6						
<b>Pullout failure</b>										
Characteristic resistance of tension load in cracked concrete C1	$N_{Rk,P,C1}$ [kN]		12,0	16,0	25,0	36,0	50,3	66,1		
	$\gamma_{Mp,C1}^{1)}$ [-]		1,5							
<b>Steel failure without lever arm</b>										
<b>Characteristic resistance of shear load C1</b>										
FH II-S	$V^0_{Rk,s,C1}$ [kN]		25,0	41,0	60,0	123,0	141,0	200,0		
FH II-B,-H			17,0	30,0	46,0	103,0	117,0	169,0		
FH II-SK	$t_{fix}^{2)}$ [mm]		$\geq 10$	$\geq 15$		-				
	$V_{Rk,s,C1}$ [kN]		25,0	41,0	60,0					
	$t_{fix}^{2)}$ [mm]		$< 10$	$< 15$						
	$V_{Rk,s,C1}$ [kN]		11,0	16,0	27,0					
Partial factor for steel failure	$\gamma_{Ms,C1}^{1)}$ [-]		1,25							
FH II-S A4	$V_{Rk,s,C1}$ [kN]		25,0	41,0	60,0	123,0	-			
Partial factor for steel failure	$\gamma_{Ms,C1}^{1)}$ [-]		1,33							
FH II-B A4,-H A4	$V_{Rk,s,C1}$ [kN]		17,0	30,0	46,0	103,0	-			
Partial factor for steel failure	$\gamma_{Ms,C1}^{1)}$ [-]		1,25							
FH II-SK A4	$t_{fix}^{2)}$ [mm]		$\geq 10$	$\geq 15$		-				
	$V_{Rk,s,C1}$ [kN]		25,0	41,0	60,0					
	$t_{fix}^{2)}$ [mm]		$< 10$	$< 15$						
	$V_{Rk,s,C1}$ [kN]		11,0	16,0	27,0					
Partial factor for steel failure	$\gamma_{Ms,C1}^{1)}$ [-]		1,33							
Factor for annular gap	$\alpha_{gap}$		0,50							

<sup>1)</sup> In absence of other national regulations

<sup>2)</sup> The thickness of the fixture has influence to the characteristic resistance for shear loads, steel failure without lever arm

<sup>3)</sup> Only valid for zinc-plated version

fischer High-Performance Anchor FH II, FH II-I

**Performances**  
Performance characteristics of tension and shear resistance for seismic performance category C1

**Annex C 7**

**Table C8.1:** Performance characteristics of **tension and shear resistance** for **seismic performance category C2** for FH II-S,-SK,-B,-H and FH II-S A4,-SK A4,-B A4,-H A4

Anchor type FH II-S,-SK,-B,-H and FH II-S A4,-SK A4,-B A4,-H A4				FH II 12	FH II 15	FH II 18	FH II 24	FH II 28 <sup>3)</sup>	FH II 32 <sup>3)</sup>
<b>Steel failure</b>									
Characteristic resistance of tension load C2	FH II-S,-SK,-B,-H -B A4, -H A4	$N_{Rk,s,C2}$ [kN]		29,3	46,4	67,4	125,3	195,8	
		$\gamma_{Ms,C2}^{1)}$ [-]		1,5					
	FH II-S A4,-SK A4	$N_{Rk,s,C2}$ [kN]		29,3	46,4	67,4	125,3	-	
		$\gamma_{Ms,C2}^{1)}$ [-]		1,6					
<b>Pullout failure</b>									
Characteristic resistance of tension load in cracked concrete C2	$N_{Rk,P,C2}$ [kN]		6,2	11,3	21,8	43,0	65,9		
	$\gamma_{Mp,C2}^{1)}$ [-]		1,5						
<b>Steel failure without lever arm</b>									
<b>Characteristic resistance of shear load C2</b>									
FH II-S	$V_{Rk,s,C2}$ [kN]		14,7	28,9	41,0	100,7			
FH II-B,-H			9,8	20,9	34,1	61,9	67,2		
FH II-SK	$t_{fix}^{2)}$ [mm]		$\geq 10$	$\geq 15$			-		
	$V_{Rk,s,C2}$ [kN]		14,8	23,3	33,8				
	$t_{fix}^{2)}$ [mm]		$< 10$	$< 15$					
	$V_{Rk,s,C2}$ [kN]		6,3	9,1	15,1				
Partial factor for steel failure	$\gamma_{Ms,C2}^{1)}$ [-]		1,25						
FH II-S A4	$V_{Rk,s,C2}$ [kN]		14,7	28,9	41,0	100,7	-		
Partial factor for steel failure	$\gamma_{Ms,C2}^{1)}$ [-]		1,33						
FH II-B A4,-H A4	$V_{Rk,s,C2}$ [kN]		9,8	20,9	34,1	61,9	-		
Partial factor for steel failure	$\gamma_{Ms,C2}^{1)}$ [-]		1,25						
FH II-SK A4	$t_{fix}^{2)}$ [mm]		$\geq 10$	$\geq 15$			-		
	$V_{Rk,s,C2}$ [kN]		14,8	23,3	33,8				
	$t_{fix}^{2)}$ [mm]		$< 10$	$< 15$					
	$V_{Rk,s,C2}$ [kN]		6,3	9,1	15,1				
Partial factor for steel failure	$\gamma_{Ms,C2}^{1)}$ [-]		1,33						
Factor for annular gap	$\alpha_{gap}$		0,50						

<sup>1)</sup> In absence of other national regulations

<sup>2)</sup> The thickness of the fixture has influence to the characteristic resistance for shear loads, steel failure without lever arm

<sup>3)</sup> Only valid for zinc-plated version

fischer High-Performance Anchor FH II, FH II-I

**Performances**

Performance characteristics of tension and shear resistance for seismic performance category C2

**Annex C 8**

**Table C9.1:** Displacements under static and quasi static **tension loads** for FH II and FH II A4

Anchor type FH II-S,-SK,-B,-H and FH II-S A4,-SK A4,-B A4,-H A4			FH II 10	FH II 12	FH II 15	FH II 18	FH II 24	FH II 28	FH II 32
Tension load cracked concrete	N	[kN]	3,6	5,7	7,6	11,9	17,1	24,0	31,5
Corresponding displacements	$\frac{\delta_{N0}}{\delta_{N\infty}}$	[mm]	1,0	1,0	1,0	1,0	1,0	0,7	0,7
			1,7	1,6	1,6	1,6	1,8	1,3	1,1
Tension load uncracked concrete	N	[kN]	6,0	11,2	14,1	17,2	24,0	33,6	44,2
Corresponding displacements	$\frac{\delta_{N0}}{\delta_{N\infty}}$	[mm]	0,6	1,0	1,0	1,0	1,0	0,3	0,3
			1,7	1,6	1,6	1,6	1,8	1,3	1,1

**Table C9.2:** Displacements under static and quasi static **tension loads** for FH II-I and FH II-I A4

Anchor type FH II-I and FH II-I A4			FH II 12/M6 I FH II 12/M8 I	FH II 15/M10 I FH II 15/M12 I
Tension load cracked concrete	N	[kN]	4,3	5,7
Tension load uncracked concrete			9,5	14,1
Corresponding displacements	$\frac{\delta_{N0}}{\delta_{N\infty}}$	[mm]	1,7	1,9
			2,2	2,9

**Table C9.3:** Displacements under static and quasi static **shear loads** for FH II-S and -SK

Anchor type FH II-S and FH II-SK			FH II 10	FH II 12	FH II 15	FH II 18	FH II 24	FH II 28	FH II 32
Shear load in cracked and uncracked concrete	V	[kN]	10,3	18,9	33,7	43,4	83,4	99,4	124,0
Corresponding displacements	$\frac{\delta_{V0}}{\delta_{V\infty}}$	[mm]	2,4	2,7	4,4	5,0	7,0	6,0	8,0
			3,6	4,1	6,6	7,5	10,5	9,0	12,0

**Table C9.4:** Displacements under static and quasi static **shear loads** for FH II-B and -H

Anchor type FH II-B and FH II-H			FH II 10	FH II 12	FH II 15	FH II 18	FH II 24	FH II 28	FH II 32
Shear load in cracked and uncracked concrete	V	[kN]	8,9	15,4	23,4	35,4	68,0	83,4	96,6
Corresponding displacements	$\frac{\delta_{V0}}{\delta_{V\infty}}$	[mm]	2,2	2,3	3,0	5,0	7,0	5,0	5,0
			3,3	3,5	4,5	7,5	10,5	7,5	7,5

fischer High-Performance Anchor FH II, FH II-I

**Performances**  
Displacements under tension and shear loads

**Annex C 9**

<b>Table C10.1:</b> Displacements under static and quasi static <b>shear loads</b> for FH II-S A4, FH II-SK A4, FH II-B A4 and FH II-H A4								
Anchor type FH II-S A4, -SK A4, -B A4, -H A4			<b>FH II 10</b>	<b>FH II 12</b>	<b>FH II 15</b>	<b>FH II 18</b>	<b>FH II 24</b>	
Shear load in cracked and uncracked concrete	V	[kN]	10,3	16,0	24,6	37,7	68,0	
Corresponding displacements	$\frac{\delta_{V0}}{\delta_{V\infty}}$	[mm]	3,5	3,5	3,7	5,7	9,0	
			5,3	5,3	5,6	8,6	13,5	
<b>Table C10.2:</b> Displacements under static and quasi static <b>shear loads</b> for FH II-I and FH II-I A4								
Anchor type: FH II-I and FH II-I A4			<b>FH II 12/M6 I</b>	<b>FH II 12/M8 I</b>	<b>FH II 15/M10 I</b>	<b>FH II 15/M12 I</b>		
Shear load in cracked and uncracked concrete	V	[kN]	4,6	8,3	13,3	13,7		
Corresponding displacements	$\frac{\delta_{V0}}{\delta_{V\infty}}$	[mm]	2,6	2,6	2,2	2,2		
			3,9	3,9	3,3	3,3		
<b>Table C10.3:</b> Displacements under <b>tension loads</b> for <b>seismic performance category C2</b> for FH II and FH II A4								
Anchor type FH II-S,-SK,-B,-H and FH II-S A4,-SK A4,-B A4,-H A4			<b>FH II 12</b>	<b>FH II 15</b>	<b>FH II 18</b>	<b>FH II 24</b>	<b>FH II 28</b>	<b>FH II 32</b>
Displacement DLS	$\delta_{N,C2 (DLS)}$	[mm]	1,55	2,63	2,04	4,26	3,06	
Displacement ULS	$\delta_{N,C2 (ULS)}$		8,71	11,07	7,30	11,70	11,44	
<b>Table C10.4:</b> Displacements under <b>shear loads</b> for <b>seismic performance category C2</b> for FH II and FH II A4								
Anchor type FH II-S,-SK and FH II-S A4,-SK A4			<b>FH II 12</b>	<b>FH II 15</b>	<b>FH II 18</b>	<b>FH II 24</b>	<b>FH II 28</b>	<b>FH II 32</b>
Displacement DLS	$\delta_{V,C2 (DLS)}$	[mm]	3,53	4,18	4,67	5,59	4,79	
Displacement ULS	$\delta_{V,C2 (ULS)}$		6,62	7,38	9,03	14,09	9,95	
Anchor type FH II-B,-H and FH II-B A4,-H A4			<b>FH II 12</b>	<b>FH II 15</b>	<b>FH II 18</b>	<b>FH II 24</b>	<b>FH II 28</b>	<b>FH II 32</b>
Displacement DLS	$\delta_{V,C2 (DLS)}$	[mm]	3,42	4,26	4,29	4,79		
Displacement ULS	$\delta_{V,C2 (ULS)}$		5,26	6,66	7,95	7,69	9,95	
fischer High-Performance Anchor FH II, FH II-I							<b>Annex C 10</b>	
<b>Performances</b> Displacements under tension and shear loads								