



EAN code
CRM-42/230V: 8595188136693
CRM-42F/230V: 8595188146883

Technical parameters	CRM-42	CRM-42/F
Function:	delay OFF responsive to control contact switch on	
Supply terminals:	A1 - A2	
Voltage range:	AC 230 V / 50 - 60 Hz	
Burden:	AC max. 12 VA / 1.8 W	
Supply voltage tolerance:	-15 %; +10 %	
Supply indication:	green LED	
Time ranges:	0.5 - 10 min	
Time setting:	potentiometer	
Time deviation:	5 % - mechanical setting	
Repeat accuracy:	5 % - set value stability	
Temperature coefficient:	0.05 % / °C, at = 20 °C (0.05 % / °F, at = 68 °F)	
Output		
Number of contacts:	1x NO - SPST (AgSnO ₂), switches potential A1	
Current rating:	16 A / AC1	
Breaking capacity:	4000 VA / AC1, 384 W / DC	
Inrush current:	30 A / < 3 s	
Switching voltage:	250 V AC1 / 24 V DC	
Output indication:	red LED	
Mechanical life:	3x10 ⁷	
Electrical life (AC1):	0.7x10 ⁵	
Electrical life (ACSb):	8x10 ⁴ (bulbs 1000 W) *	
Control		
Control voltage:	AC 230 V	
Input Burden:	AC 0.53 VA	
Glow tubes connctions:	Yes	
Max. amount of glow lamps connected to controlling input:	230 V - max. amount 50 pcs (measured with glow lamp 0.68 mA / 230 V AC)	
Control. terminals:	A1-S or A2-S	
Impulse length:	min. 50 ms / max. unlimited	
Reset time:	max. 150 ms	
Other information		
Operating temperature:	-20 °C to +55 °C (-4 °F to 131 °F)	
Storage temperature:	-30 °C to +70 °C (-22 °F to 158 °F)	
Operating position:	any	
Mounting:	DIN rail EN 60715	
Protection degree:	IP40 from front panel / IP10 terminals	
Overvoltage category:	III.	
Pollution degree:	2	
Max. cable size (mm ²):	solid wire max. 2x 2.5 or 1x 4, with sleeve max. 1x 2.5 or 2x 1.5, (AWG 12)	
Dimensions:	90 x 17.6 x 64 mm (3.5" x 0.7" x 2.5")	
Weight:	65 g (2.3 oz.)	
Standards:	EN 60669-2-3, EN 61010-1	

- Intelligent staircase switch, the same use as CRM-4, but with enlarged possibility of control in mode „PROG“, it is possible to select time of delayed OFF by number of button pressing. Each pressing multiplies time set by potentiometer, it means that in case you set time to 5 min and press the button 3 times, then the output is automatically prolonged to 15 min. Output can be also switched off before time (reset) by long pressing of button (longer than 2 sec).
- Output relay contact 16 A/AC1 with inrush current up to 80 A enables switching of el. bulbs and also fluorescent lights.
- Operating system switch:
 - ON - output is constantly ON (service mode).
 - AUTO - timing according to adjusting by potentiometer in range 30 s - 10 min.
 - PROG - timing with time prolongation option by number button pressing.
- Timing (in mode AUTO and PROG) is possible to be stopped by long pressing of the button (> 2 s).
- Voltage range: AC 230 V, clamp terminals.
- Output indication: multif. red LED, flashing at certain states
- 3-wire or 4-wire connection (it is possible to control input S by potential A1 or A2).
- CRM-42:** Warning before switch OFF- output doubleflash 40 and 30 sec before switch OFF.
- CRM-42F:** Staircase switch without warning flashes especially suited for use with energy-saving lamps, where frequent flashing may cause damage to the light source.
- 1- MODULE, DIN rail mounting.

Description

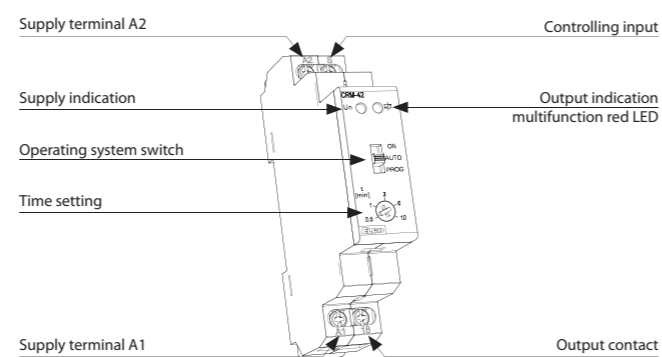

Connection

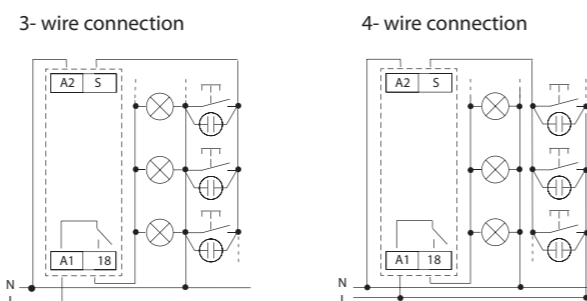

Symbol

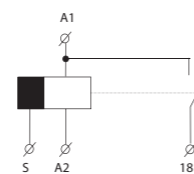

* For bigger bulb loads and frequent switching is recommended to intensify the contact relay with power contactor e.g. VSXXX

Function

MODE ON

- the output is permanently closed in ON position. Control input is blocked.

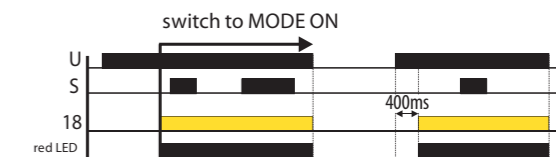

MODE AUTO

- by pressing a control button in function AUTO the output closes and after the set time period the output opens.

CRM-42: Warning before switch OFF- output doubleflash 40 and 30 sec before switch OFF*

CRM-42F: without flashing

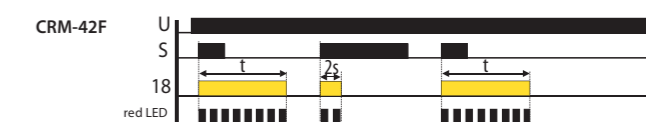
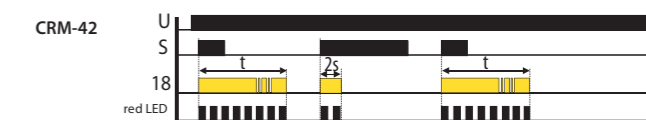

MODE PROG (the illumination time is defined by number of button pressing)

- in function program the switched time is a sum of each time set by pressing the button. By pressing >2s the output opens.

CRM-42: Warning before switch OFF- output doubleflash 40 and 30 sec before switch OFF*

CRM-42F: without flashing

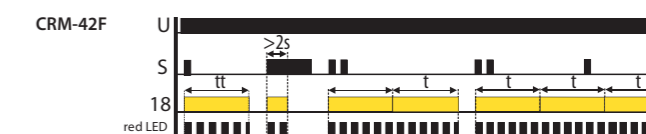
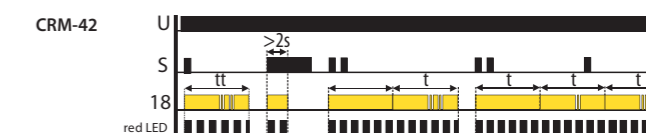

* If the total set time is less than 1 min, there is no flashing according to the graph of the function.