



**INSTYTUT TECHNIKI BUDOWLANEJ**  
PL 00-611 WARSZAWA  
ul. Filtrowa 1  
tel.: (+48 22) 825-04-71  
(+48 22) 825-76-55  
fax: (+48 22) 825-52-86  
www.itb.pl



Member of



## European Technical Assessment

**ETA-17/0303  
of 28/09/2018**

### General Part

**Technical Assessment Body issuing the European Technical Assessment**

Instytut Techniki Budowlanej

**Trade name of the construction product**

S-IPT 8/p and S-IPT 8/s

**Product family to which the construction product belongs**

Screwed-in plastic anchors for fixing of external thermal insulation composite systems with rendering in concrete and masonry

**Manufacturer**

pgb-Polska Sp. z o.o.  
ul. Fryderyka Wilhelma Redena 3  
PL 41-807 Zabrze  
Poland

**Manufacturing plant**

pgb-Polska Sp. z o.o.  
ul. Fryderyka Wilhelma Redena 3  
PL 41-807 Zabrze  
Poland

**This European Technical Assessment contains**

15 pages including 3 Annexes which form an integral part of this Assessment

**This European Technical Assessment is issued in accordance with regulation (EU) No 305/2011, on the basis of**

European Assessment Document EAD 330196-01-0604 "Plastic anchors made of virgin or non-virgin material for fixing of external thermal insulation composite systems with rendering"

*This European Technical Assessment is issued by the Technical Assessment Body in its official language. Translations of this European Technical Assessment in other languages shall fully correspond to the original issued document and shall be identified as such.*

*Communication of this European Technical Assessment, including transmission by electronic means, shall be in full. However, partial reproduction may only be made with the written consent of the issuing Technical Assessment Body. Any partial reproduction has to be identified as such.*

## Specific Part

### 1 Technical description of the product

The S-IPT 8/p screwed in plastic anchor consists of sleeve with a plate made of polypropylene (virgin material) and an accompanying screw made of the glass fibre reinforced polyamide.

The S-IPT 8/s screwed in plastic anchor consists of sleeve with a plate made of polypropylene (virgin material) and an accompanying screw made of zinc plated carbon steel with head covered with glass fibre reinforced polyamide.

The S-IPT8/p and S-IPT 8/s anchors may in addition be combined with the additional plates IWP  $\varnothing$ 90 mm and IWP  $\varnothing$ 140 mm, made of the glass fibre reinforced polyamide or polypropylene.

The drawings and the description of the products are given in Annex A.

### 2 Specification of the intended use in accordance with the applicable European Assessment Document (EAD)

The performances given in clause 3 are only valid if the anchor is used in compliance with the specifications and conditions given in Annex B.

The provisions made in this European Technical Assessment are based on an assumed working life of the anchor of 25 years. The indications given on the working life cannot be interpreted as a guarantee given by the producer or Technical Assessment Body, but are to be regarded only as a means for choosing the right products in relation to the expected economically reasonable working life of the works.

### 3 Performance of the product and references to the methods used for its assessment

#### 3.1 Performance of the product

##### 3.1.1 Safety in use (BWR 4)

Essential characteristic	Performance
Characteristic resistance	Annex C1
Edge distances and spacing	Annex B2
Plate stiffness	Annex C2
Displacements	Annex C3

##### 3.1.2 Energy economy and heat retention (BWR 6)

Essential characteristic	Performance
Point thermal transmittance of an anchor	Annex C2

#### 3.2 Methods used for the assessment

The assessment of the products has been made in accordance with the EAD 330196-01-0604 "Plastic anchors made of virgin or non-virgin material for fixing of external thermal insulation composite systems with rendering".

**4 Assessment and verification of constancy of performance (AVCP) system applied, with reference to its legal base**

According to the Decision 97/463/EC of the European Commission of 27 June 1997 the system 2+ of assessment and verification of constancy of performance (see Annex V to the Regulation (EU) No 305/2011) applies.

**5 Technical details necessary for the implementation of the AVCP system, as provided in the applicable European Assessment Document (EAD)**

Technical details necessary for the implementation of the AVCP system are laid down in the control plan deposited in Instytut Techniki Budowlanej.

For the type testing the results of the tests performed as part of the assessment for the European Technical Assessment shall be used unless there are changes in the production line or plant. In such cases the necessary type testing has to be agreed between Instytut Techniki Budowlanej and the notified body.

Issued in Warsaw on 28/09/2018 by Instytut Techniki Budowlanej

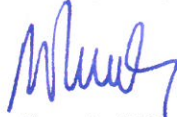

Anna Panek, MSc  
Deputy Director of ITB



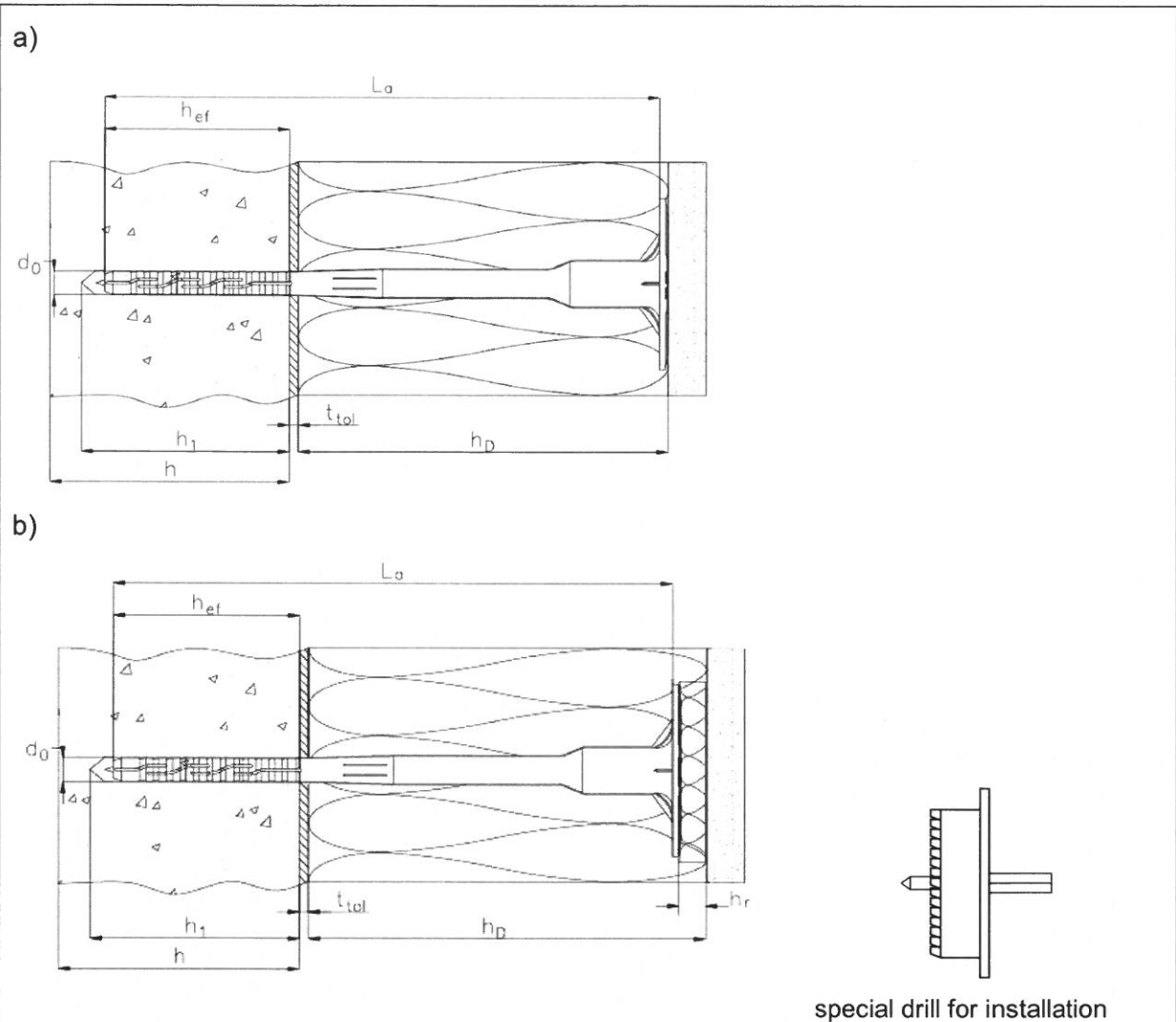

**Intended Use**

Fixing of external thermal insulation composite systems in concrete and masonry

**Legend**

- $d_0$  = drill diameter
- $h_{ef}$  = effective anchorage depth
- $h_1$  = depth of drill hole in base material
- $h$  = thickness of base material
- $h_D$  = thickness of insulation material
- $t_{tol}$  = thickness of equalizing and/or non-load-bearing layer
- $h_r$  = thickness of styrofoam disc

<b>S-IPT 8/p and S-IPT 8/s</b>	<b>Annex A1</b> of European Technical Assessment ETA-17/0303
<b>Product description</b> Installation conditions	

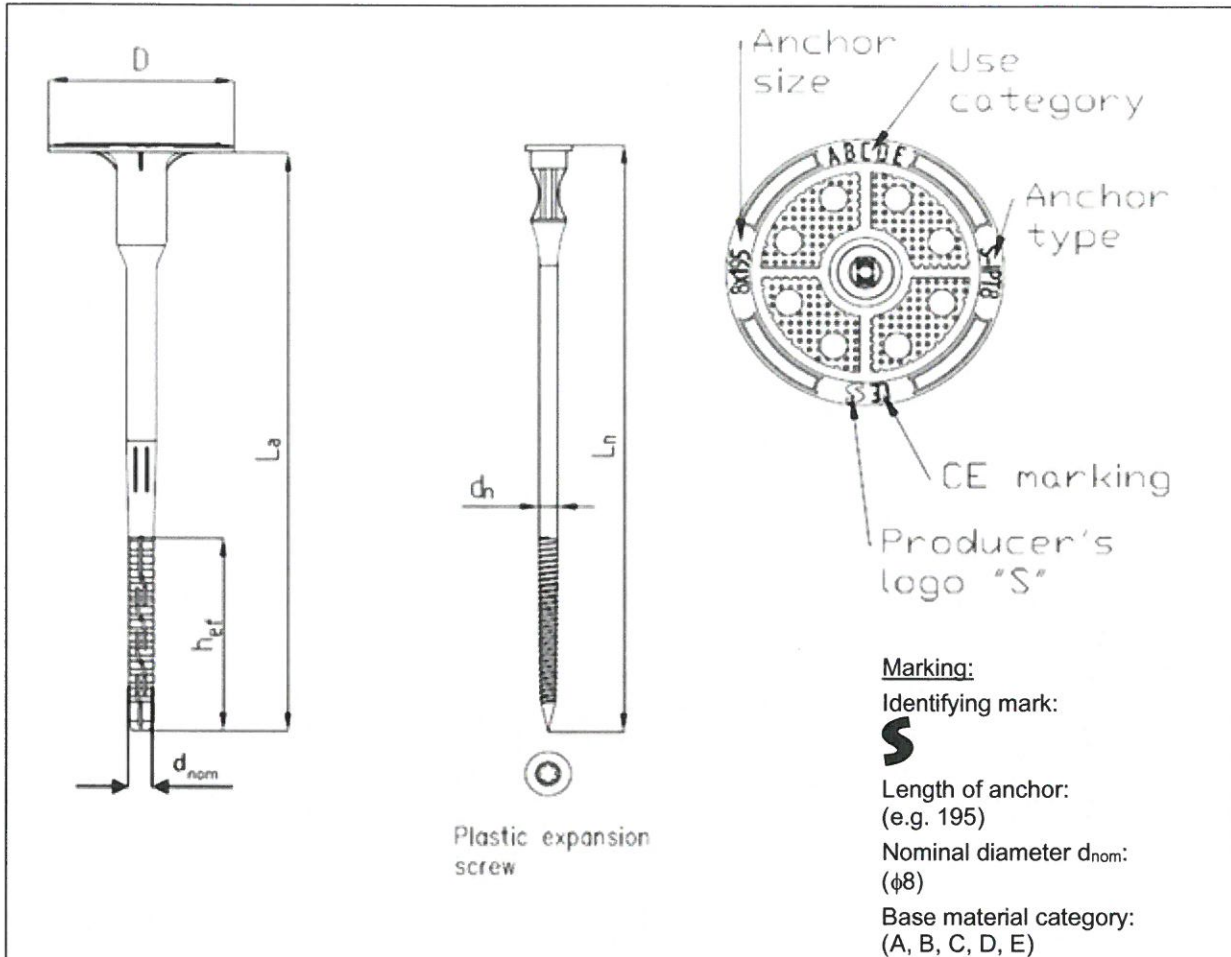

**Table A1: S-IPT 8/p anchor types and dimensions [mm]**

Anchor type	S-IPT 8/p anchor sleeve					S-IPT 8/p expansion pin	
	$d_{nom}$	$L_a$	$D$	$h_{ef}$ (ABCD)	$h_{ef}$ (E)	$d_n$	$L_n$
S-IPT 8/p x 95	8,0	95	60	35	50	6,0	100
S-IPT 8/p x 115	8,0	115	60	35	50	6,0	120
S-IPT 8/p x 135	8,0	135	60	35	50	6,0	140
S-IPT 8/p x 155	8,0	155	60	35	50	6,0	160
S-IPT 8/p x 175	8,0	175	60	35	50	6,0	180
S-IPT 8/p x 195	8,0	195	60	35	50	6,0	200
S-IPT 8/p x 215	8,0	215	60	35	50	6,0	220
S-IPT 8/p x 235	8,0	235	60	35	50	6,0	240
S-IPT 8/p x 255	8,0	255	60	35	50	6,0	260
S-IPT 8/p x 275	8,0	275	60	35	50	6,0	280
S-IPT 8/p x 295	8,0	295	60	35	50	6,0	300

$h_{ef}$  (ABCD) – for anchors in the base material category A, B, C and D

$h_{ef}$  (E) – for anchors in the base material category E

Determination of maximum thickness of insulation material:  $h_D = L_a - t_{tol} - h_{ef}$

<b>S-IPT 8/p and S-IPT 8/s</b>	<b>Annex A2</b> of European Technical Assessment ETA-17/0303
<b>Product description</b> Marking and dimensions of the S-IPT 8/p anchors	

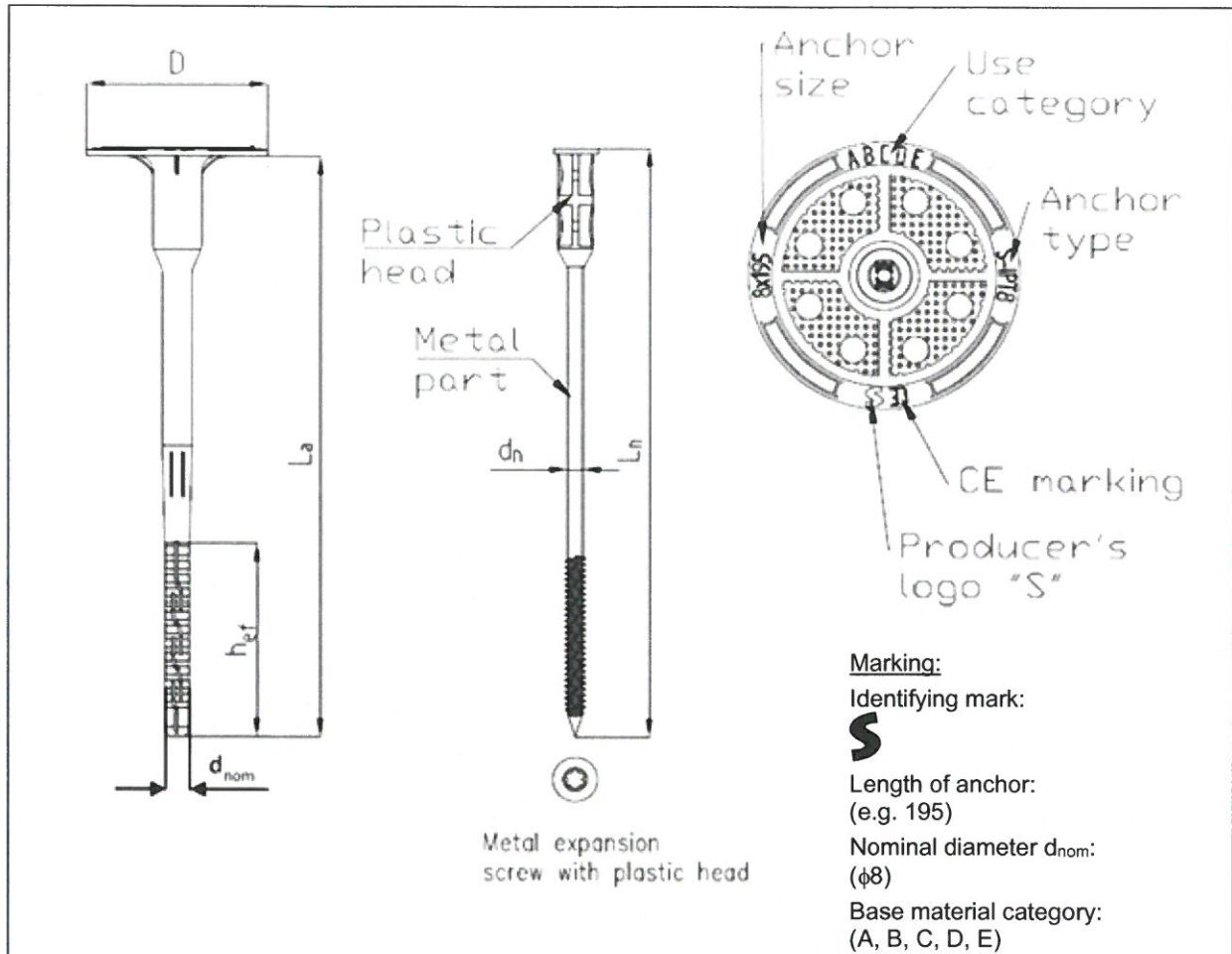

**Table A2: S-IPT 8/s anchor types and dimensions [mm]**

Anchor type	S-IPT 8/s anchor sleeve					S-IPT 8/s expansion pin	
	$d_{nom}$	$L_a$	$D$	$h_{ef}$ (ABCD)	$h_{ef}$ (E)	$d_n$	$L_n$
S-IPT 8/s x 95	8,0	95	60	35	50	5,7	100
S-IPT 8/s x 115	8,0	115	60	35	50	5,7	120
S-IPT 8/s x 135	8,0	135	60	35	50	5,7	140
S-IPT 8/s x 155	8,0	155	60	35	50	5,7	160
S-IPT 8/s x 175	8,0	175	60	35	50	5,7	180
S-IPT 8/s x 195	8,0	195	60	35	50	5,7	200
S-IPT 8/s x 215	8,0	215	60	35	50	5,7	220
S-IPT 8/s x 235	8,0	235	60	35	50	5,7	240
S-IPT 8/s x 255	8,0	255	60	35	50	5,7	260
S-IPT 8/s x 275	8,0	275	60	35	50	5,7	280
S-IPT 8/s x 295	8,0	295	60	35	50	5,7	300

$h_{ef}$  (ABCD) – for anchors in the base material category A, B, C and D

$h_{ef}$  (E) – for anchors in the base material category E

Determination of maximum thickness of insulation material:  $h_D = L_a - t_{tol} - h_{ef}$

<b>S-IPT 8/p and S-IPT 8/s</b>	<b>Annex A3</b> of European Technical Assessment ETA-17/0303
<b>Product description</b> Marking and dimensions of the S-IPT 8/s anchors	

**Table A3: Materials**

<b>Designation</b>	<b>Material</b>
Anchor sleeve S-IPT 8/p and S-IPT 8/s	Virgin material: Polypropylene (gray or natural)
Expansion pin S-IPT 8/p	Glass fibre reinforced polyamide (black)
Expansion pin S-IPT 8/s	Carbon steel ( $f_{y,k} \geq 220$ MPa, $f_{u,k} \geq 360$ MPa), galvanized $\geq 5$ $\mu\text{m}$ according to EN ISO 4042, with head coated with glass fibre reinforced polyamide (black)

**S-IPT 8/p and S-IPT 8/s**

**Product description**  
Materials

**Annex A4**  
of European  
Technical Assessment  
ETA-17/0303



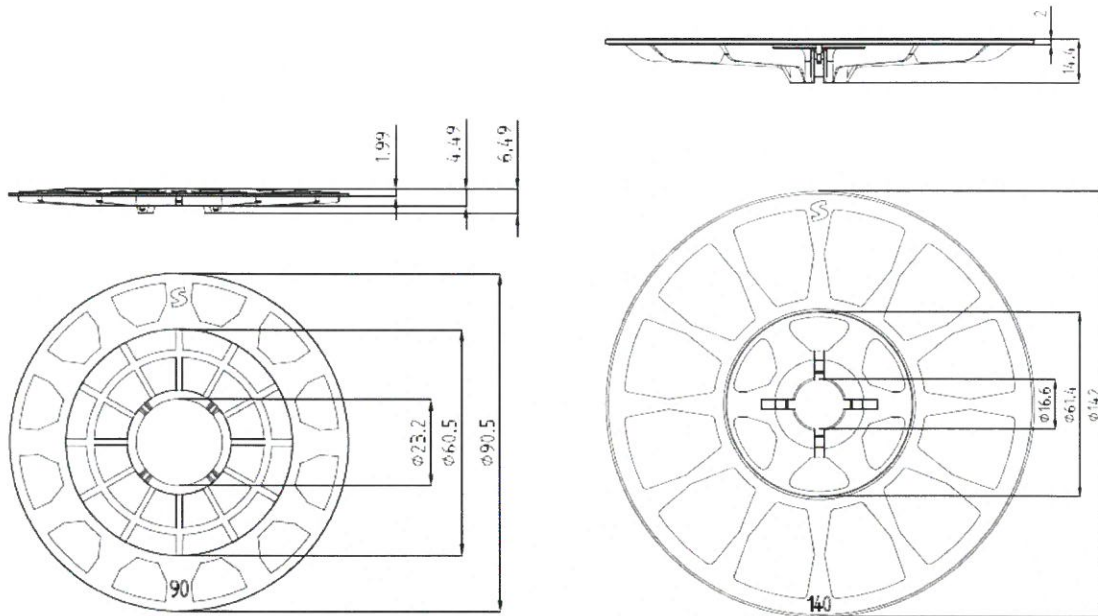

**Table A4: Additional plate IWP ø90 mm**

Plate type	Outer diameter [mm]	Material
IWP ø90 mm	90	Glass fibre reinforced polyamide (gray) or polypropylene (natural)

**Table A5: Additional plate IWP ø140 mm**

Plate type	Outer diameter [mm]	Material
IWP ø140 mm	140	Glass fibre reinforced polyamide (gray) or polypropylene (natural)

**S-IPT 8/p and S-IPT 8/s**

**Product description**  
 Additional plates IWP ø90 mm and IWP ø140 mm, used in combination with S-IPT 8/p and S-IPT 8/s anchor sleeve

**Annex A5**  
 of European  
 Technical Assessment  
 ETA-17/0303

**Specification of intended use**

**Anchorage subject to:**

- Wind suction loads.  
 Note: The anchor shall not be used for the transmission of dead loads of the external thermal insulation composite system.

**Base materials:**

- Reinforced or unreinforced normal weight concrete (use category A), according to Annex C1 and C3.
- Solid masonry (use category B), according to Annex C1 and C3.
- Hollow or perforated masonry (use category C), according to Annex C1 and C3.
- Lightweight aggregate concrete (use category D), according to Annex C1 and C3.
- Autoclaved aerated concrete (use category E), according to Annex C1 and C3.
- For other base materials of the use categories A, B, C, D or E the characteristic resistance of the anchor may be determined by job site tests according to EOTA Technical Report TR 051, edition December 2016.

**Application temperature range:**

- 0°C to +40°C (max. short term temperature +40°C and max. long term temperature +24°C).

**Design:**

- The anchorages are designed under the responsibility of an engineer experienced in anchorages and masonry work with the partial safety factors  $\gamma_M = 2,0$  and  $\gamma_F = 1,5$ , if there are no other national regulations.
- Verifiable calculation notes and drawings with anchor positions are prepared taking into account of the loads to be anchored.
- Fasteners are only to be used for multiple fixings of thermal insulation composite system (ETICS).

**Installation:**

- Hole shall be drilled by the drill modes according to Annex C1.
- Anchor installation shall be carried out by appropriately qualified personnel and under the supervision of the person responsible for technical matters of the site.
- Installation shall be executed in temperature from 0°C to +40°C.
- Exposure to UV due to solar radiation of the anchor not protected by rendering shall not exceed 6 weeks.

<b>S-IPT 8/p and S-IPT 8/s</b>	<b>Annex B1</b> of European Technical Assessment ETA-17/0303
<b>Intended use Specifications</b>	

**Table B1: Installation characteristics**

Anchor type		S-IPT 8/p	S-IPT 8/s
Nominal diameter of drill bit	$d_0$ [mm]	8	8
Cutting diameter of drill bit	$d_{cut}$ [mm]	$\leq 8,45$	$\leq 8,45$
Depth of drill hole for base material category A, B, C, D	$h_1$ [mm]	$\geq 40$	$\geq 40$
Effective anchorage depth for base material category A, B, C, D	$h_{ef}$ [mm]	$\geq 35$	$\geq 35$
Depth of drill hole for base material category E	$h_1$ [mm]	$\geq 55$	$\geq 55$
Effective anchorage depth for base material category E	$h_{ef}$ [mm]	$\geq 50$	$\geq 50$

**Table B2: Minimum thickness of base material, edge distance and anchor spacing**

Anchor type		S-IPT 8/p and S-IPT 8/s
Minimum thickness of base material	$h_{min}$ [mm]	100
Minimum spacing	$s_{min}$ [mm]	100
Minimum edge distance	$c_{min}$ [mm]	100

Diagram of spacing

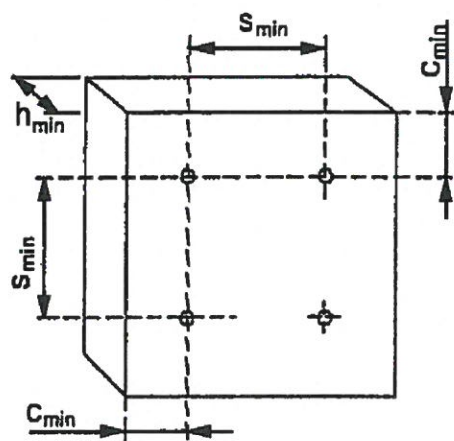

S-IPT 8/p and S-IPT 8/s

**Intended use**  
Installation characteristics, minimum thickness of base material, edge distance and spacing

**Annex B2**  
of European  
Technical Assessment  
ETA-17/0303



**Installation instruction:**

a)

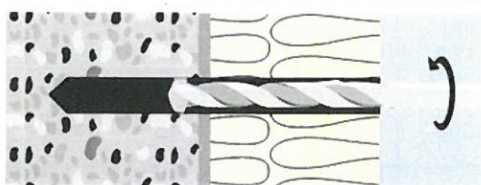
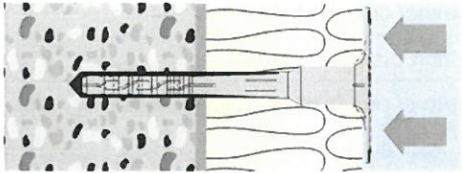
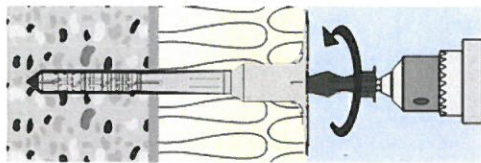
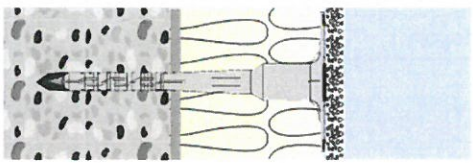
 <p>1. Drill the hole by corresponding drilling method acc. to Annex C1. Drill perpendicular.</p>	 <p>2. Clean the hole. Set-in the anchor and make sure that the plate bottom is flush with the ETICS surface.</p>
 <p>3. Screw-in the expansion pin (Tx30).</p>	 <p>4. Correctly installed anchor.</p>

b)

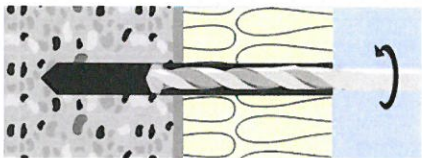
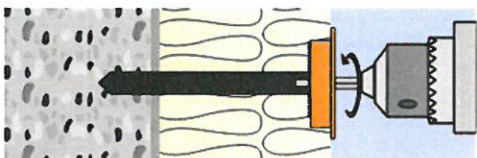
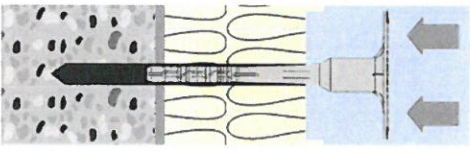
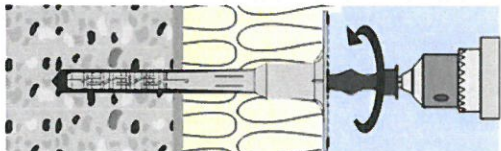
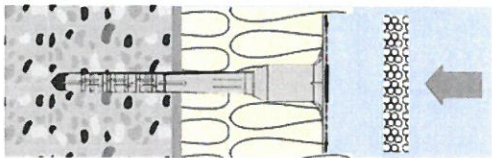
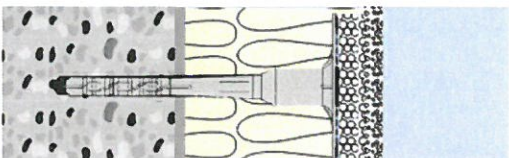
 <p>1. Drill the hole by corresponding drilling method acc. to Annex C1. Drill perpendicular.</p>	 <p>2. Clean the drill hole. Drill the recess in the installation with the corresponding tool.</p>
 <p>3. Set-in the anchor and make sure that the plate bottom is flush with the ETICS surface.</p>	 <p>4. Screw-in the expansion pin (Tx30).</p>
 <p>5. The crumble zone will contract during the screwing. Place the styrofoam disc.</p>	 <p>6. Correctly installed anchor.</p>







**S-IPT 8/p and S-IPT 8/s**

**Intended use**  
Installation instruction

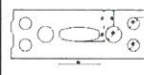
**Annex B3**  
of European  
Technical Assessment  
ETA-17/0303



**Table C1: Characteristic resistance to tension loads  $N_{Rk}$  in concrete and in masonry for single S-IPT 8/p and S-IPT 8/s anchors**

Base material	Bulk density [kg/dm <sup>3</sup> ]	Compressive strength [N/mm <sup>2</sup> ]	Referring standard	$N_{Rk}$ [kN]		Drill method	
				S-IPT 8/p	S-IPT 8/s		
Concrete C12/15 (use category A)			EN 206	1,5	0,8	hammer	
Concrete C16/20 + C50/60 (use category A)			EN 206	1,5	1,1	hammer	
Clay bricks MZ (use category B)	≥ 2,0	≥ 20,0	EN 771-1	1,5	1,2	hammer	
Clay bricks MZ+H (use category B)	≥ 2,0	≥ 20,0	EN 771-1	1,3	0,65	hammer	
Calcium silicate bricks KS (use category B)	≥ 2,0	≥ 20,0	EN 771-2	1,5	1,2	hammer	
Calcium silicate hollow blocks KSL (use category C)	 	≥ 1,6	≥ 12,0	EN 771-2	1,5	0,9	rotary
Vertically perforated clay bricks porotherm (use category C)	 	≥ 1,2	≥ 12,0	EN 771-1	1,0	0,55	rotary
Vertically perforated clay bricks MAX (use category C)	 	≥ 0,8	≥ 10,0	EN 771-1	0,5	0,25	rotary
Lightweight concrete blocks LAC (use category D)		≥ 0,88	≥ 5,0	EN 771-3	1,1	1,0	rotary
Lightweight concrete blocks LAC+H (use category D)		≥ 0,88	≥ 5,0	EN 771-3	1,2	0,45	rotary
Autoclaved concrete blocks AAC 2 (use category E)		≥ 0,35	≥ 2,0	EN 771-4	1,4	0,8	rotary
Autoclaved concrete blocks AAC 7 (use category E)		≥ 0,65	≥ 3,5	EN 771-4	1,4	0,8	rotary
Partial safety factor for anchor resistance, $\gamma_M^{(1)}$	2,0						
<sup>(1)</sup> in the absence of national regulations							

S-IPT 8/p and S-IPT 8/s

Performances  
Characteristic resistanceAnnex C1  
of European  
Technical Assessment  
ETA-17/0303

**Table C2: Plate stiffness according to EOTA Technical Report TR 026**







Anchor type	Diameter of the anchor plate $d_{plate}$ [mm]	Characteristic load resistance of the anchor plate [kN]	Plate stiffness [kN/mm]
S-IPT 8/p and S-IPT 8/s	60	2,87	0,4

**Table C3: Point thermal transmittance according to EOTA Technical Report TR 025**

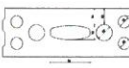
Anchor type	Insulation thickness $H_D$ [mm]	Point thermal transmittance $\chi$ [W/K]
S-IPT 8/p	95	0
	105	0
	150	0
	445	0
S-IPT 8/s	95	0,003
	105	0,003
	150	0,003
	445	0,002

<b>S-IPT 8/p and S-IPT 8/s</b>	<b>Annex C2</b> of European Technical Assessment ETA-17/0303
<b>Performances</b> Plate stiffness and point thermal transmittance	

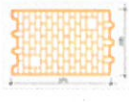
**Table C4: Displacements for S-IPT 8/p and S-IPT 8/s anchors**

Base material	Bulk density [kg/dm <sup>3</sup> ]	Compressive strength [N/mm <sup>2</sup> ]	$\frac{N_{RK}}{3}$ [kN]		$\delta\left(\frac{N_{RK}}{3}\right)$ [mm]		
			S-IPT 8/p	S-IPT 8/s	S-IPT 8/p	S-IPT 8/s	
Concrete C12/15 (use category A)			0,5	0,27	0,29	0,20	
Concrete C16/20 + C50/60 (use category A)			0,5	0,37	0,39	0,27	
Clay bricks MZ (use category B)	≥ 2,0	≥ 20,0	0,5	0,4	0,38	0,13	
Clay bricks MZ+H (use category B)	≥ 2,0	≥ 20,0	0,43	0,22	0,20	0,37	
Calcium silicate bricks KS (use category B)	≥ 2,0	≥ 20,0	0,5	0,4	0,38	0,26	
Calcium silicate hollow blocks KSL (use category C)	 	≥ 1,6	≥ 12,0	0,5	0,3	0,23	0,31
Vertically perforated clay bricks porotherm (use category C)	 	≥ 1,2	≥ 12,0	0,33	0,18	0,26	0,32
Vertically perforated clay bricks MAX (use category C)	 	≥ 0,8	≥ 10,0	0,16	0,08	0,53	0,15
Lightweight concrete blocks LAC (use category D)		≥ 0,88	≥ 5,0	0,37	0,33	0,28	0,22
Lightweight concrete blocks LAC+H (use category D)		≥ 0,88	≥ 5,0	0,4	0,15	0,51	0,18
Autoclaved concrete blocks AAC 2 (use category E)		≥ 0,35	≥ 2,0	0,47	0,27	0,46	0,16
Autoclaved concrete blocks AAC 7 (use category E)		≥ 0,65	≥ 3,5	0,47	0,27	0,40	0,24

<b>S-IPT 8/p and S-IPT 8/s</b>	<b>Annex C3</b> of European Technical Assessment ETA-17/0303
<b>Performances</b> Displacements	

